

SMART Board® 400 series interactive display overlay

User's guide

Extraordinary made simple™

SMART™

Product registration

If you register your SMART product, we'll notify you of new features and software upgrades.

Register online at smarttech.com/registration.

Keep the following information available in case you need to contact SMART Support.

Serial number:

Date of purchase:

FCC warning

This equipment has been tested and found to comply with the limits for a Class A digital device, pursuant to Part 15 of the US Federal Communications Commission Rules. These limits are designed to provide reasonable protection against harmful interference when the equipment is operated in a commercial environment. This equipment generates, uses and can radiate radio frequency energy and, if not installed and used in accordance with the manufacturer's instructions, may cause harmful interference to radio communications. Operation of this equipment in a residential area is likely to cause harmful interference in which case the user will be required to correct the interference at his own expense.

Trade-mark notice

SMART Board, SMART Notebook, SMART Meeting Pro, SMART GoWire, DVIT, smarttech, the SMART logo and all SMART taglines are trade-marks or registered trade-marks of SMART Technologies ULC in the US and/or other countries. Windows is either a registered trade-mark or a trade-mark of Microsoft Corporation in the US and/or other countries. Mac and Macintosh are trade-marks of Apple Inc., registered in the US and other countries. All other third-party product and company names may be trade-marks of their respective owners.

Copyright notice

© 2011 SMART Technologies ULC. All rights reserved. No part of this publication may be reproduced, transmitted, transcribed, stored in a retrieval system or translated into any language in any form by any means without the prior written consent of SMART Technologies ULC. Information in this manual is subject to change without notice and does not represent a commitment on the part of SMART. One or more of the following patents: US6320597; US6326954; US6563491; US6741267; US6947032; US6954197; US7151533; US7411575; US7499033; US7619617; US7629987; US7643006; US7692625; US7757001; US7880720; US7932899; USD612396; USD616462; USD617332; and USD636784. Other patents pending.

10/2011

Important information for your interactive display overlay

WARNING

- Failure to follow the installation instructions included with your SMART product could result in personal injury and damage to the product which may not be covered by your warranty.
- Ensure that any cables extending across the floor to your SMART product are properly bundled and marked to avoid a trip hazard.
- You must connect the USB cable that came with your interactive display overlay to a computer that has a USB compliant interface and that bears the USB logo. In addition, the USB source computer must be compliant with CSA/UL/EN 60950 and bear the CE mark and CSA and/or UL Mark(s) for CSA/UL 60950. This is for operating safety and to avoid damage to the interactive display overlay which may not be covered by your warranty.
- To reduce the risk of fire or electric shock, do not expose the SMART product to rain or moisture.

CAUTION

- Before you clean your SMART product, shut down or disconnect the computer. Otherwise, you may scramble the desktop icons or inadvertently activate applications when you wipe the screen.
- Do not use harsh cleaners on your interactive display overlay screen because these products could damage the screen.
- Do not spray cleaners directly onto your screen. Spray onto a cloth first and then clean the screen.
- Do not clean the cameras in the corners of the interactive display overlay unless you are directed to by SMART Support.
- Avoid setting up and using the SMART product in an area with excessive levels of dust, humidity and smoke.

Contents

Important information for your interactive display overlay	iii
Chapter 1: About your interactive display overlay	1
Your SMART Board 400 series interactive display overlay.....	2
Features of your interactive display overlay.....	2
Accessories and replacement parts.....	3
Chapter 2: Setting up your interactive display overlay	5
Installing your interactive display overlay.....	5
Connecting your interactive display overlay to your computer.....	7
Chapter 3: Installing SMART software	9
Identifying your SMART software package.....	9
Installing SMART Meeting Pro software.....	10
Connecting a SMART GoWire cable.....	10
Installing SMART Notebook software.....	11
Chapter 4: Using your interactive display overlay	13
Orientating your interactive display overlay.....	13
Using touch control.....	14
Using multitouch gestures in Windows 7 operating system.....	15
Using SMART Meeting Pro software.....	15
Using SMART Notebook software.....	17
Chapter 5: Maintaining your interactive display overlay	19
Cleaning your interactive display overlay.....	19
Updating SMART software.....	20
Transporting your interactive display overlay.....	20
Chapter 6: Troubleshooting your interactive display overlay	21
Appendix A: Hardware environmental compliance	23
Waste Electrical and Electronic Equipment regulations (WEEE directive).....	23
Restriction of Certain Hazardous Substances (RoHS directive).....	23
Packaging.....	23
Covered electronic devices.....	24
China's Electronic Information Products regulations.....	24
Restriction of Certain Chemicals (REACH directive).....	24

Chapter 1

About your interactive display overlay

Your SMART Board 400 series interactive display overlay.....	2
Features of your interactive display overlay.....	2
Software.....	2
Touch.....	2
DViT® (Digital Vision Touch) technology.....	2
USB cable.....	3
Accessories and replacement parts.....	3

When you mount your SMART Board® 400 series interactive display overlay on a compatible flat-panel display and connect it to a computer with SMART software, you have touch control of your computer's desktop from your interactive display overlay screen and can write and erase digital ink.

CHAPTER 1

Introducing your SMART Board interactive display overlay

Your SMART Board 400 series interactive display overlay

Use the illustration below to familiarise yourself with the components of your interactive display overlay.

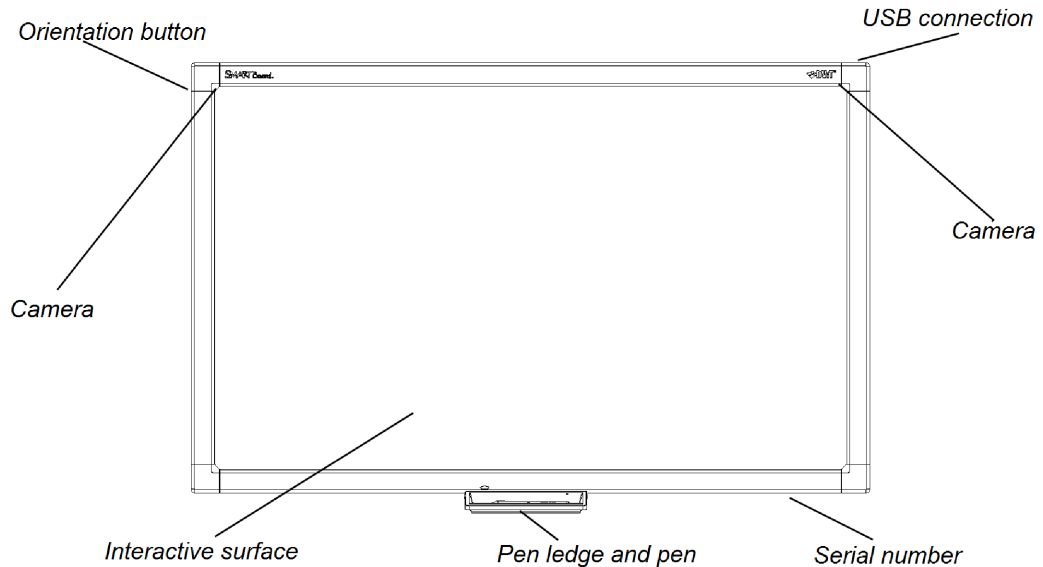

Features of your interactive display overlay

Software

To use all of the features of your interactive display overlay described in this guide, ensure that you have the latest version of SMART software and SMART Product Drivers installed on your computer.

Touch

Perform mouse functions with your finger, write in digital ink with the pen included and erase digital ink.

DViT® (Digital Vision Touch) technology

DViT technology uses cameras in the corners of the frame to track contact with the surface of the interactive display overlay.

CHAPTER 1

Introducing your SMART Board interactive display overlay

USB cable

The USB cable included provides both power to your interactive display overlay and touch control of your desktop.

Accessories and replacement parts

The following products can be used with your interactive display overlay.

CAT5-XT	Cat 5 USB extender. You require a powered hub to use a Cat 5 USB extender with the interactive display overlay.
RPENLEDGE-SBID4	Replacement pen ledge for the SMART Board 400 series interactive display overlay.
RPEN-SBID4	Replacement pen and nibs for the SMART Board 400 series interactive display overlay.
GW-MP	SMART GoWire™ auto-launch cable for business.

Chapter 2

Setting up your interactive display overlay

Installing your interactive display overlay.....	5
Connecting your interactive display overlay to your computer.....	7
Extending your connection with a CAT5 to USB extenderconnection.....	8

This chapter includes information on installing an interactive display overlay on an LCD or plasma flat-panel display and then connecting it to a computer.

Installing your interactive display overlay

You can install your interactive display overlay on a wall-mounted or stand-mounted flat-panel display.

WARNING

- Ensure that your wall can support the weight of your flat-panel display, your interactive display overlay and any mounting hardware. Refer to the relevant local building codes and regulations.
- Two people are required to mount your SMART product because it may be too heavy for one person to safely manoeuvre.

IMPORTANT

For more information, see the *SMART Board 400 series interactive display overlay textless installation guide* (smarttech.com/kb/160507).

CHAPTER 2

Setting up your interactive display overlay

To install your interactive display overlay

1. Place your interactive display overlay face down on a tabletop.
2. Attach the pen ledge to the bottom frame of the interactive display overlay with the two screws included.

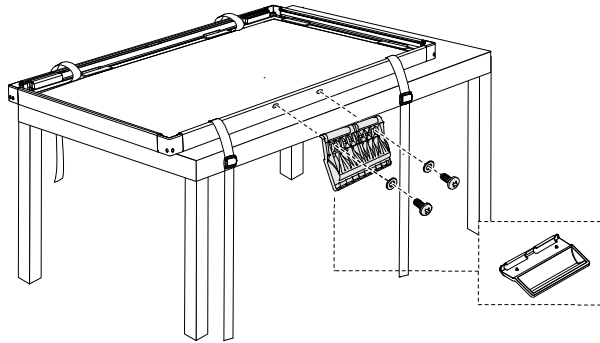

3. Attach the spacers included to the interactive display overlay, if required.

IMPORTANT

For a complete list of compatible flat-panel displays and the spacers they require for a secure fit, see the *SMART Board 400 series interactive display overlay flat-panel display fit list* (smarttech.com/kb/160508).

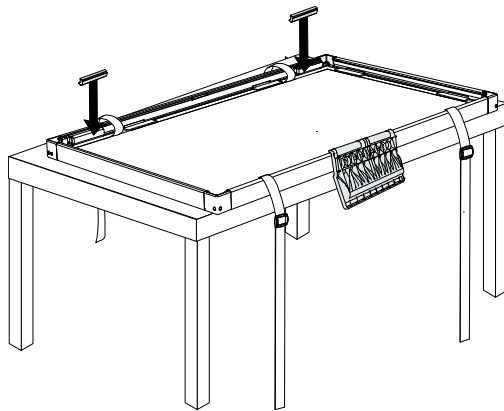

4. If the flat-panel display is wall-mounted, remove it from the wall mount and lay it face down on the interactive display overlay.

OR

If the flat-panel display is stand-mounted, lift the interactive display overlay onto the flat-panel display.

5. Tighten the straps to secure the interactive display overlay to the flat-panel display.

CHAPTER 2

Setting up your interactive display overlay

6. If the flat-panel display was wall-mounted, return the flat-panel display and interactive display overlay to the wall mount.

Connecting your interactive display overlay to your computer

Connect the included 3m (9' 10") USB cable from your computer to your interactive display overlay to provide power to your interactive display overlay and enable touch control of your computer's desktop. You will also need a video cable (not included) to connect your computer to your flat-panel display.

■ To connect your interactive display overlay and your flat-panel display to your computer

1. Connect a video cable from your computer to your flat-panel display.
2. Turn on your computer and your flat-panel display.



IMPORTANT

The flat-panel display must be either the only display for your computer or a clone of your computer's primary display. The flat-panel display cannot be your computer's secondary display.

3. Connect the included USB cable from your computer to the USB connector at the upper left back corner of your interactive display overlay.

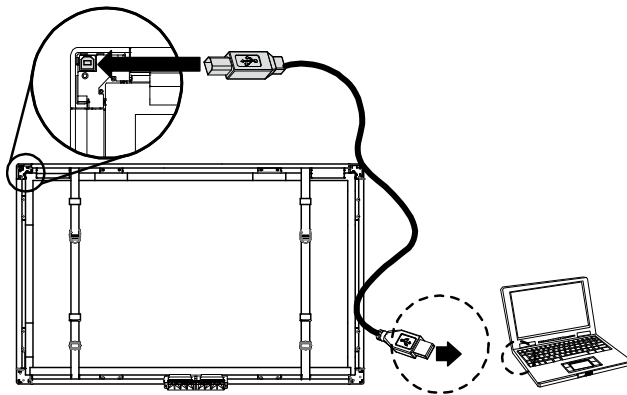

NOTE

You can substitute a 5m (16' 5") USB cable.

CHAPTER 2

Setting up your interactive display overlay

Extending your connection with a CAT5 to USB extender connection

If your computer will be further than 5m (16' 5") from your interactive display overlay, you can use a CAT5 to USB extender and a powered hub to connect them. You must connect the extender to a powered hub at the interactive display overlay. If you do not, you might not have enough power to operate the interactive display overlay.

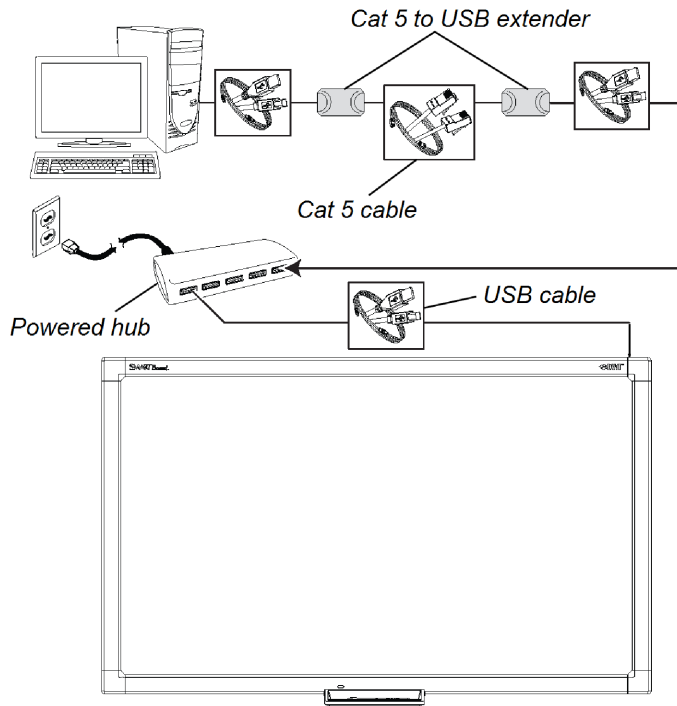

Chapter 3

Installing SMART software

Identifying your SMART software package.....	9
Installing SMART Meeting Pro software.....	10
Connecting a SMART GoWire cable.....	10
Installing SMART Notebook software.....	11

You must install SMART software on the computer connected to your interactive display overlay to use all the features of your interactive display overlay.

Identifying your SMART software package

The SMART software that you're entitled to depends on which model of interactive display overlay you purchased.

If your interactive display overlay model number includes the suffix “-MP” (for example, SBID-S442-MP), you're entitled to SMART Meeting Pro™ software. You can either download software from smarttech.com/downloads or use the SMART GoWire cable included.

If your interactive display overlay model number doesn't include the suffix “-MP” (for example, SBID-S442), you're entitled to SMART Notebook™ collaborative learning software. Install the software from the included DVD.

Installing SMART Meeting Pro software

Install SMART Meeting Pro software if your interactive display overlay model number includes the suffix “-MP”.

IMPORTANT

SMART Meeting Pro software is available only for computers with Windows operating systems. For more information, see the release notes in the *Related documents* section of the SMART Meeting Pro software downloads page.

To install SMART Meeting Pro software

1. Go to smarttech.com/downloads.
2. Click **SMART Meeting Pro software**.
3. Click **Download** and then follow the on-screen instructions to save the executable file to your desktop.
4. Double-click the executable file and then follow the on-screen instructions.
5. Go to smarttech.com/registration to register your interactive display overlay and receive a software product key.

Connecting a SMART GoWire cable

You can connect a SMART GoWire cable from your interactive display overlay to your computer to access the features of SMART Meeting Pro software without installing the software on your computer.

A SMART GoWire cable is included in all SBID-4XX-MP series models. It is not included in SBID-4XX series models.

You must connect your computer SMART GoWire cable to a computer with a Windows operating system. For other computer requirements, see the *SMART GoWire cable for SMART Meeting Pro and SMART Meeting Pro Premium software specifications* (smarttech.com/kb/151506).

IMPORTANT

Your interactive display overlay requires a SMART GoWire cable 2.3 or later. If you have an earlier version, you can upgrade its firmware at smarttech.com/downloads.

CHAPTER 3

Installing SMART software

■ To connect a SMART GoWire cable

1. If your computer is connected to your interactive display overlay by a USB cable, then disconnect the USB cable from your computer.
2. Connect the SMART GoWire cable to the USB cable.
3. Connect the auto-launch cable's USB connector to a USB connector on your computer.
The *AutoPlay* dialogue box opens.
4. Select the **Start SMART Meeting Pro** option.
SMART Meeting Pro software starts.

■ To disconnect a SMART GoWire cable

1. Save your work as a .ppt, .pdf or .notebook file.
2. Press the SMART Meeting Pro icon  in the notification area and then select **Exit**.
3. Disconnect the SMART GoWire cable from your laptop and your interactive display overlay.

Installing SMART Notebook software

If your interactive display overlay included a SMART Notebook software DVD, you can install SMART Notebook software to access more features for your interactive display overlay.

IMPORTANT

Connect to the Internet before you install SMART software so that you can obtain a software product key and download software updates.

NOTE

A SMART Notebook software DVD isn't included with interactive display overlay SBID-4XX-MP models, but you can download SMART Notebook software from smarttech.com/downloads and register your interactive display overlay to receive a product key.

■ To install SMART Notebook software from the DVD

1. Place the DVD in your computer's DVD tray.
The installation wizard appears.
2. Follow the on-screen instructions. You'll be prompted to type your product key.

CHAPTER 3

Installing SMART software

3. Click the **SMART Board** icon  in the notification area (Windows operating systems) or the Dock (Mac operating system software) and then select **Check for Updates and Activation**.
The *SMART Product Update* window appears.
4. Follow the on-screen instructions to update SMART Notebook software and SMART Product Drivers to their latest versions.
5. Go to smarttech.com/registration to register your interactive display overlay and receive a software product key.
6. Type your product key in the installation wizard and follow the on-screen instructions to complete the installation.

Chapter 4

Using your interactive display overlay

Orientating your interactive display overlay.....	13
Using touch control.....	14
Using multitouch gestures in Windows 7 operating system.....	15
Using SMART Meeting Pro software.....	15
Using SMART Business Toolbar tools.....	16
Using other tools.....	17
Using SMART Notebook software.....	17
Using Floating Tools.....	18
Floating Tools.....	18

Your interactive display overlay enables you to perform mouse functions with your finger.



With SMART software installed, you can draw digital ink, erase digital ink, open an on-screen keyboard and more.

Orientating your interactive display overlay

Orientate your interactive display overlay in the following situations:

- When you install your interactive display overlay for the first time
- When you move the interactive display overlay on the flat-panel display
- When your touch doesn't register accurately

■ To orientate the interactive display overlay

1. Press the **SMART Board** icon  or the **SMART Meeting Pro** icon  in the notification area (Windows operating systems) or Dock (Mac operating system software) and then select **Orientate**.

OR

CHAPTER 4

Using your interactive display overlay

Press the Orientation button near the top left-hand corner of your interactive display overlay.

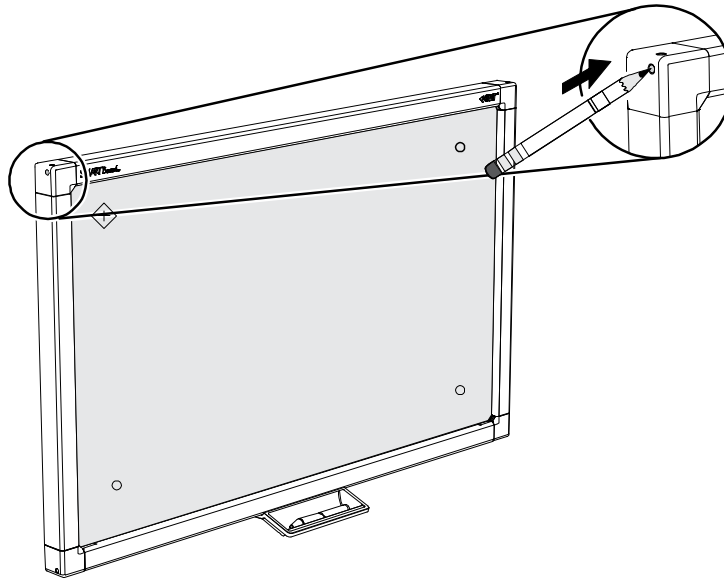

The orientation screen appears.

2. Hold your finger or pen steadily on the centre of the red target until you hear the buzzer and then lift your finger or pen away from the screen.

IMPORTANT

Ensure that your finger or pen is at a right angle to the interactive surface.

The target moves to the next position.

3. Repeat step 2 for each target that appears.

IMPORTANT

Lift your finger or pen straight off the screen. Do not drag it across the screen.

4. Test the orientation by moving the pointer around the screen using your finger or pen.

If touch is still inaccurate, orientate your interactive display overlay again.

Using touch control

Even without SMART software, your interactive display overlay enables touch control as if your touch was a mouse.

To open a file or folder

Double-press the file or folder icon.

CHAPTER 4

Using your interactive display overlay

■ To move a file or folder

Press the file or folder icon and then drag it.

Using multitouch gestures in Windows 7 operating system

If you have a Windows 7 operating system with multitouch gestures enabled and have SMART software on your computer, you can use the following multitouch gestures on your interactive display overlay.

- Zoom
- Single finger pan
- Two finger pan
- Rotate
- Two finger tap
- Press and tap



IMPORTANT

- If you are unable to use these gestures on a computer with Windows 7 operating system, download the Windows 7 multitouch driver for the SMART Board 400 series interactive display overlay from smarttech.com/downloads.
- Multitouch gestures do not work when SMART Notebook software or SMART Meeting Pro software are in Whiteboard mode.

Using SMART Meeting Pro software

If SMART Meeting Pro software is installed on your computer, you can access the features of SMART Meeting Pro software.



NOTE

Press **Help** or **F1** to access SMART Meeting Pro software help.

CHAPTER 4

Using your interactive display overlay











Using SMART Business Toolbar tools

Once you have installed SMART Meeting Pro software, the SMART Business Toolbar gives you easy access to a variety of tools that you'll use frequently.

For more information, see the SMART Meeting Pro software Help.



NOTE

The available SMART Business Toolbar tools change depending on which mode SMART Meeting Pro software is in. The tools are unavailable in Organiser mode.

Tool	Name	Action
	Cursor	Select, move and manipulate objects on a Whiteboard page.
	Pen	Select pen colours and widths that you can use to write notes and create freehand objects. You can also select a transparent yellow or green highlighter.
	Eraser	Erase notes and objects created with digital ink.
	Shapes	Draw a variety of shapes, including circles, rectangles, stars, squares and others. You can also use this tool to select solid or broken lines and arrows. Available in Desktop and Whiteboard modes.
	Text	Insert text into your Whiteboard page. When you touch the page, a text box appears where you can select the formatting of your text object. Available in Whiteboard mode.
	Capture	Take a screen capture of your notes and automatically insert them on a Whiteboard page. Open a list of three options so you can capture the full screen, a rectangular selection or freehand selection of your screen. Available in Desktop and View Screens modes.
	Undo	Reverse the effect of your previous action or command.
	Redo	Reinstate the last action reversed with the Undo command. Redo applies to actions on the current page only. Available in Whiteboard mode.
	Clear All	Clear all notes and shapes from your interactive product screen. Available in Desktop mode.
	Normal View	Restore the Whiteboard page to Normal view. Available in Whiteboard mode when in Full Whiteboard view.







CHAPTER 4

Using your interactive display overlay

Tool	Name	Action
	Previous Page	Display the previous page of the current file. You can also press the PAGE UP key on your keyboard. Available in Whiteboard mode when in Full Whiteboard view and on the Page Sorter when in Normal view.
	Next Page	Display the next page of the current file. You can also press the PAGE DOWN key on your keyboard. If you press Next Page on the last page, Whiteboard inserts a new page. Available in Whiteboard mode when in Full Whiteboard view and on the Page Sorter when in Normal view.

Using other tools

In addition to SMART Recorder, SMART Video Player and SMART Keyboard, you can use these additional tools with your interactive product by pressing **Programs** and then selecting the tool.

Tool	Name	Action
	Keyboard	Open the SMART Keyboard.
	Screen Shade	Add a Screen Shade to the screen.
	Spotlight	Open a Spotlight window.
	Magnifier	Open a Magnification window.
	Recorder	Start SMART Recorder.
	Pointer	Display a large pointer.

Using SMART Notebook software

If SMART Notebook software is installed on your computer, you can access the features of SMART Notebook software.

■ To open SMART Notebook software

Open Floating Tools (see page 18) and then press the **SMART Notebook** icon .

NOTE

Press **Help** or **F1** to access SMART Notebook software help.

CHAPTER 4

Using your interactive display overlay

Using Floating Tools

Once you have installed SMART Notebook software, the Floating Tools tab appears on the left-hand side of your desktop.

For more information, see the SMART Notebook software Help.









To open or close Floating Tools

Press the double arrows on the Floating Tools tab.



Floating Tools

The following table shows the default tools on Floating Tools.

Tool	Name	Action
	Select	Perform a left-click.
	Pen (×2)	Write or draw in digital ink using your finger or the included pen. There are two pens of different colours on Floating Tools. You can change the colour of either pen.
	Highlighter	Highlight in digital ink with your finger or the pen included.
	Eraser	Erase digital ink.
	Right-Click	Perform a right-click.
	Keyboard	Open the on-screen keyboard.
	Notebook	Start SMART Notebook software.
	Undo	Reverse the effect of your last action or command.
	Customise	Customise the contents of Floating Tools to add more tools. For more information on additional tools, see the SMART Notebook software Help.

Chapter 5

Maintaining your interactive display overlay

Cleaning your interactive display overlay.....	19
Updating SMART software.....	20
Transporting your interactive display overlay.....	20

Properly maintained, your interactive display overlay will provide years of service.

Cleaning your interactive display overlay

CAUTION

- Before you clean your SMART product, shut down or disconnect the computer. Otherwise, you may scramble the desktop icons or inadvertently activate applications when you wipe the screen.
- Do not use harsh cleaners on your interactive display overlay screen because these products could damage your screen.
- Do not spray directly onto your screen. Spray onto a cloth first and then clean the screen.
- Do not clean the cameras in the corners of your interactive display overlay unless directed by SMART Technologies support staff.



To clean your interactive display overlay

1. Turn off your computer and then disconnect the USB cable.
2. Spray a small amount of water onto a soft and lint-free cloth.
3. Wipe the glass of the touch screen to remove any dirt, dust or finger marks.
4. Wipe the clear surfaces around the edges of the screen.
5. Remove any residual water with a dry, soft and lint-free cloth.

Updating SMART software

You can check for software updates with your SMART Product Update or by going to smarttech.com/downloads.

■ To check for software updates

1. Start your SMART software program.
2. Press the **SMART Board** icon  or the **SMART Meeting Pro** icon  in the Windows notification area or Mac Dock and then select **Check for Updates and Activation**.

IMPORTANT

If you don't see the *Check for Updates and Activation* option, contact your network administrator.

3. Press the **Update** button beside the software that you want to update.

The software updates.

Transporting your interactive display overlay

Save your original packaging so that you can repack your interactive display overlay with as much of the original packaging as possible if you need to transport it. This packaging was designed for optimal shock and vibration protection.

If your original packaging isn't available, you can purchase the same packaging from your authorised SMART reseller.

CAUTION

Transport your interactive display overlay only in original or replaced packaging. Transporting your interactive display overlay without correct packaging voids your warranty and could lead to product damage.

Chapter 6

Troubleshooting your interactive display overlay

This section provides some solutions to issues that could occur with your interactive display overlay.

Issue	Recommendation
You don't see your computer desktop on the screen.	Connect your computer to your interactive display overlay with a video cable.
You don't have touch control.	Ensure that your computer is connected to your interactive display overlay with a USB cable. For more information, see page 5. If you are using a Cat 5 USB extender OR you are using a 5m (16' 5") USB cable with a SMART GoWire cable, use a powered hub.
Your touch control is inaccurate.	Orientate your interactive display overlay. For more information, see page 13. If you have an issue with orientating the interactive display overlay, contact your SMART support provider for assistance.
You can't draw or write digital ink.	Install SMART software. For more information, see page 9.
The pointer moves erratically.	Ensure that nothing is touching the screen or blocking the view of the cameras.
A "USB not recognised" message appears.	Disconnect and then connect the USB cable.

If the issue persists, contact SMART technical support (smarttech.com/ContactSupport).

Appendix A

Hardware environmental compliance

SMART Technologies supports global efforts to ensure that electronic equipment is manufactured, sold and disposed of in a safe and environmentally friendly manner.

Waste Electrical and Electronic Equipment regulations (WEEE directive)

Waste Electrical and Electronic Equipment regulations apply to all electrical and electronic equipment sold within the European Union.

When you dispose of any electrical or electronic equipment, including SMART Technologies products, we strongly encourage you to properly recycle the electronic product when it has reached the end of its life. If you require further information, please contact your reseller or SMART Technologies for information on which recycling agency to contact.

Restriction of Certain Hazardous Substances (RoHS directive)

This product meets the requirements of the European Union's Restriction of Certain Hazardous Substances (RoHS) directive 2002/95/EC.

Consequently, this product also complies with other regulations that have arisen in various geographical areas and that reference the European Union's RoHS directive.

Packaging

Many countries have regulations restricting the use of certain heavy metals in product packaging. The packaging used by SMART Technologies to transport products complies with applicable packaging laws.

APPENDIX A

Hardware environmental compliance

Covered electronic devices

Many US states classify monitors as covered electronic devices and regulate their disposal. Applicable SMART Technologies products meet the requirements of the covered electronic devices regulations.

China's Electronic Information Products regulations

China regulates products that are classified as EIP (Electronic Information Products). SMART Technologies products fall under this classification and meet the requirements for China's EIP regulations.

Restriction of Certain Chemicals (REACH directive)

The European Union has enacted the REACH directive which restricts the use of certain chemicals in products. SMART Technologies is committed to complying with this initiative.

SMART Technologies

smarttech.com/support

smarttech.com/contactsupport