

Installation and User's Guide

AirLiner™ WS100 Wireless Slate

Product Registration

If you register your SMART product, we'll notify you of new features and software upgrades.

Register online at www.smarttech.com/registration.

Keep the following information available, in case you need to contact Technical Support:

Serial Number _____

Date of Purchase _____

FCC Warning

This device complies with Part 15 of the FCC Rules. Operation is subject to the following two conditions: (1) this device may not cause harmful interference, and (2) this device must accept any interference received, including interference that may cause undesired operation.

This equipment has been tested and found to comply with the limits for a Class B digital device, pursuant to Part 15 of FCC Rules. These limits are designed to provide reasonable protection against harmful interference in a residential installation.

This equipment generates, uses and can radiate radio frequency energy and, if not installed and used in accordance with the instructions, may cause harmful interference to radio communications. However, there is no guarantee that interference will not occur in a particular installation.

You can determine whether the equipment is causing interference by disconnecting it from your computer. If the interference stops, it was probably caused by the equipment.

If the equipment does cause interference to radio or television reception, you may be able to correct the interference by using one or more of the following measures:

- Rotate the television or radio antenna until the interference stops.
- Move the equipment farther away from the television or radio.
- Plug the equipment and computer into an outlet that is on a different circuit from the television or radio.

If necessary, consult SMART Technologies ULC or an experienced radio/television technician for help.

Changes or modifications to this product not authorized by SMART Technologies ULC could void the FCC Certification and negate your authority to operate the product.

Trademark Notice

AirLiner, SMART Board, Sympodium, Notebook, smarttech and the SMART logo are trademarks or registered trademarks of SMART Technologies ULC in the U.S. and/or other countries. Windows is either a registered trademark or a trademark of Microsoft Corporation in the U.S. and/or other countries. Mac is a registered trademark of Apple Computer, Inc., registered in the U.S. and other countries. Linux is a registered trademark of Linus Torvalds. Bluetooth is a trademark owned by Bluetooth SIG, Inc. and is used by SMART Technologies ULC under license. All other third-party product and company names may be trademarks of their respective owners.

Copyright Notice

© 1992–2008 SMART Technologies ULC. All rights reserved. No part of this publication may be reproduced, transmitted, transcribed, stored in a retrieval system or translated into any language in any form by any means without the prior written consent of SMART Technologies ULC. Information in this manual is subject to change without notice and does not represent a commitment on the part of SMART.

Portions of the software that ships with this product are copyrighted by Intel® Corporation.

Portions of the software that ships with this product are copyrighted by ParaGraph, a business unit of Vadem.

Patent No. US5448263; US6141000; US6326954; US6337681; US6741267; US6747636; US7151533; and CA2058219. Other patents pending.

Printed in Canada 01/2008

Important Information

Read this installation guide carefully before setting up and using your AirLiner™ WS100 wireless slate.

WARNING



Keep batteries out of the reach of children.

WARNING



Do not puncture, crush, heat or disassemble the battery, expose it to fire or liquid, short its terminals, or abuse the battery in any other way. Doing so can cause the battery to explode or ignite, and can cause a fire or personal injury.

WARNING



If the battery leaks, do not allow battery fluid to come in contact with your eyes. If battery fluid comes in contact with your eyes, immediately rinse the affected eye(s) with water and seek medical attention.

WARNING



If you drop the battery on a hard surface, replace the battery, even if there's no obvious damage to it. It may be damaged internally. Replacing the battery prevents potential damage to the slate that can occur if a damaged battery leaks after you install it.

WARNING



Do not install the battery backwards or reverse its polarity. Do not install other battery types in your AirLiner slate. Doing so can damage the slate and can cause a fire or personal injury.

WARNING



Do not install the battery in a device other than the AirLiner slate. It is unsafe to install or recharge the AirLiner slate battery in any other device.

WARNING



Do not recharge the battery with a power adapter other than the one included with the AirLiner slate. Do not recharge other battery types in your AirLiner slate using the included power adapter. Doing so can damage the slate and can cause a fire or personal injury.

If the AirLiner slate becomes excessively warm or emits an unusual smell when the battery is recharging, immediately disconnect the power adapter from the power outlet and turn off the slate.

WARNING

When you dispose of the lithium ion battery, cover the terminals with adhesive tape to prevent contact with metal objects. As an additional precaution, do not transport the battery with metal objects. If the battery comes in contact with a metal object, the battery can short and can cause a fire or personal injury.

WARNING

When regulations require that wireless devices be turned off—for example, on a commercial aircraft—turn off the AirLiner slate and ensure that it cannot be accidentally turned on.

WARNING

Do not use the AirLiner slate in a facility control system or environment that requires high reliability, or where the use of wireless devices can cause interference. The slate can interfere with, or cause, other electronic devices to malfunction, and other wireless devices can interfere with, or cause, the AirLiner slate to malfunction.

Where its use is prohibited, turn off the slate to prevent it from interfering with other electronic devices or causing other electronic devices to malfunction. SMART Technologies does not accept liability for direct or consequential damages.

CAUTION

Avoid exposing the AirLiner slate to extreme hot or cold temperatures. The operating temperature range is between 32°F and 104°F (0°C and 40°C). The AirLiner slate works best at room temperature.

CAUTION

Do not disassemble the AirLiner WS100 wireless slate or its tools. If you disassemble the slate or its tools, you void your warranty.

CAUTION

Do not attempt to twist the tethered pen open. It must remain as a sealed unit, in order to work correctly.

CAUTION

To maintain the sensitivity of your pen tip, do not store the tethered pen in a container where it rests on its tip.

CAUTION

Do not clean the slate with volatile liquids such as paint thinner or benzene. They can damage the overlay. Instead, regularly clean the slate with a soft, damp cloth to remove dust and dirt particles. If necessary, dampen the cloth using mild soap diluted with water.

CAUTION



When you are not using the AirLiner slate and its tools, store them in a clean, dry place.

CAUTION



If the AirLiner slate battery charge is nearly empty and you do not connect the slate to a power outlet, you risk draining the battery completely. The AirLiner slate continues to draw a small amount of battery charge, even when it is turned off.

CAUTION



If you will not be using your slate for an extended period of time (one month or longer), fully recharge the battery, and then remove it from the slate.

CAUTION



Recharge the battery as often as possible, so that it does not lose all of its charge. A battery that has lost all of its charge can no longer be recharged.

IMPORTANT



Do not leave the tethered pen or cordless mouse on the slate's workspace when you are not using them. They can interfere with pointer positioning.

Table of Contents

Important Information	i
About the AirLiner™ WS100 Wireless Slate	1
Features	1
Installing the Slate	5
Enabling the Wireless Connection	5
Installing the Battery.....	6
Recharging the Battery	8
Installing the Paper Underlay	13
Installing the Tethered Pen.....	16
Installing SMART Board Software.....	18
Turning on the Slate and Creating a Wireless Connection	19
Turning on the Slate.....	19
Creating a Wireless Connection Between the AirLiner Slate and Your Computer.....	20
Reestablishing the Wireless Connection.....	22
Disconnecting the AirLiner Slate from Your Computer.....	23
Turning off the Slate.....	24
Using the Slate and its Tools	25
Using the Battery-Free Tethered Pen.....	26
Using the Cordless Mouse	33
Using the Function Buttons	34
Locking the AirLiner Slate	34
Customizing the Slate	37
Customizing the Tethered Pen.....	37
Customizing the Function Buttons	44
Printing and Customizing Underlays	46
Mapping to Multiple Displays	51
Maintaining the Slate	53
Cleaning the Slate.....	53
Replacing the Tethered Pen Tip.....	54
Replacing the Battery.....	55
Troubleshooting	57
Optimizing the Bluetooth Wireless Connection	57
Troubleshooting Scenarios	58
Regulatory Compliance	67
Waste Electrical and Electronic Equipment Regulations	67
Restriction of Certain Hazardous Substances (RoHS) Directives.....	67

Customer Support	69
Online Support	69
Training	69
Contacting SMART Technical Support	69
General Inquiries	69
Warranty	70
Registration	70
Index	71

About the AirLiner™ WS100 Wireless Slate

With the AirLiner™ WS100 wireless slate you can interact wirelessly with your computer, SMART Board™ interactive whiteboard or Sympodium™ interactive pen display from up to 52' (16 m) away. The battery-free tethered pen allows you to control software programs, write notes, and highlight information in digital ink. Multiple slate users can write at the same time as someone at a SMART Board interactive whiteboard.

Features

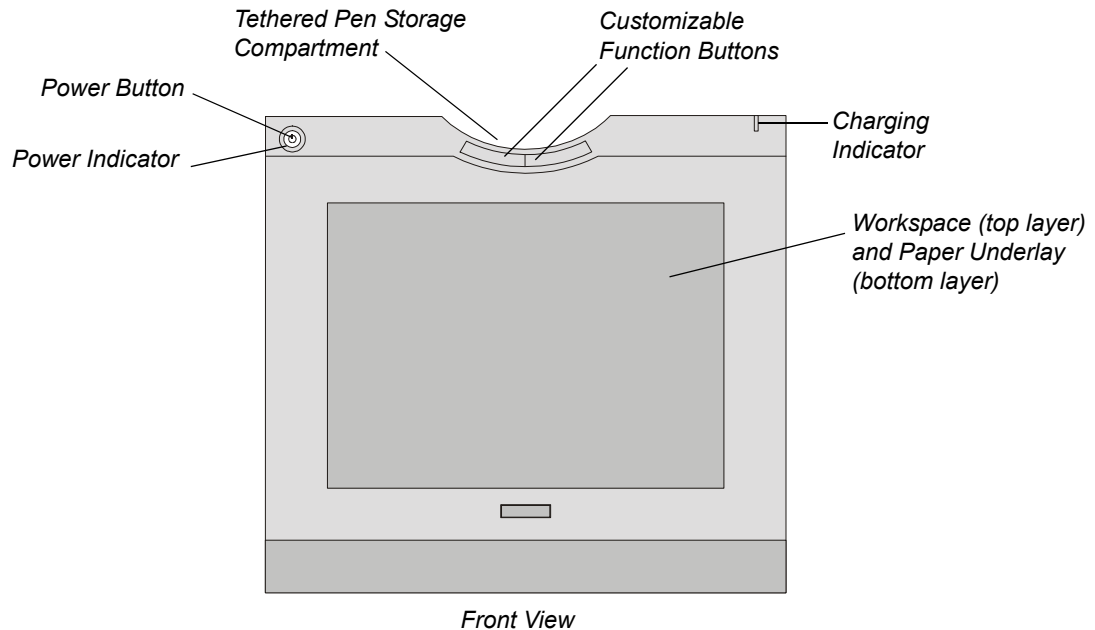

- The slate's workspace detects the tethered pen and cordless mouse within 1/4" (6.5 mm) of its surface.
- The customizable function buttons can be set to right-click, middle-click, next page, previous page, start Floating Tools, start Notebook™ software, and more (see page 44).
- The power indicator displays the slate's current operational status (see page 10).
- The charging indicator displays the battery status when the power adapter is connected (see page 9).
- The pen storage compartment conveniently and safely stores the battery-free tethered pen.

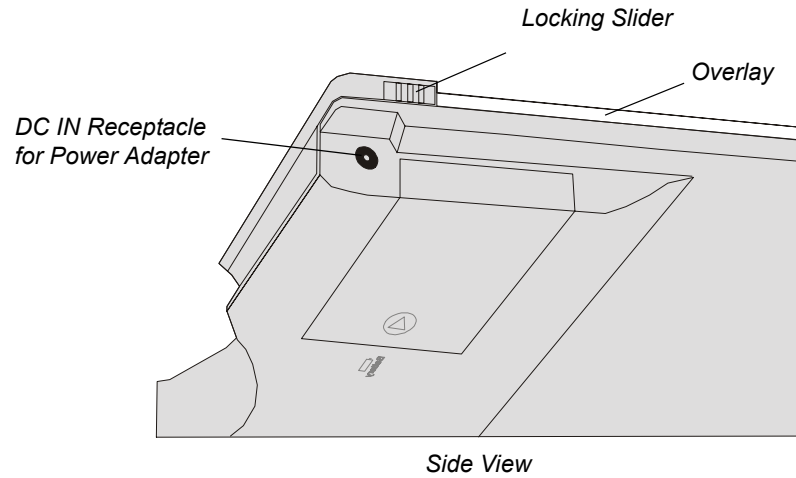

- A paper underlay, installed between the overlay and the workspace, allows you to select customizable tools and start programs when working with your slate (see page 30).

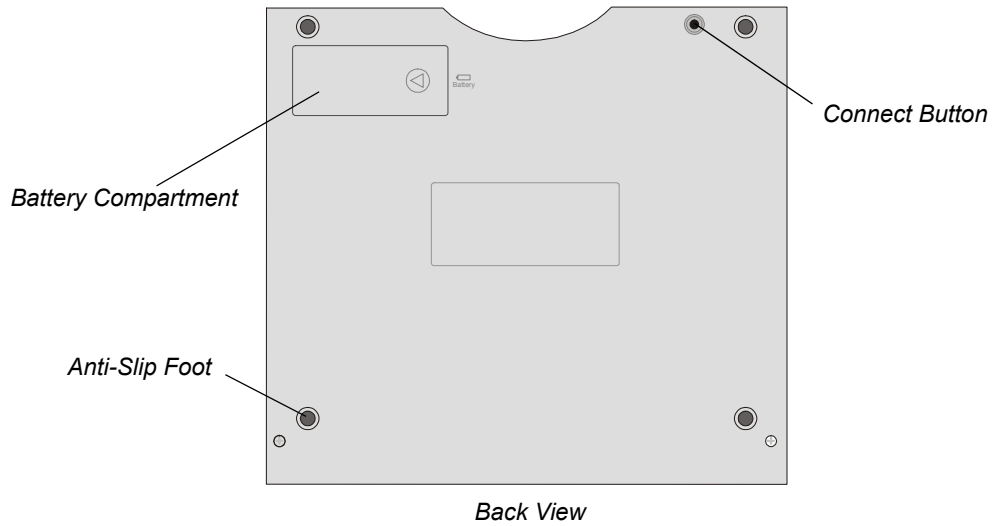

- The **Connect** button switches the slate to discoverable mode, enabling a wireless connection to your computer (see page 21).
- The battery compartment houses the rechargeable lithium ion battery (see page 6).
- Anti-slip feet keep the slate stable on flat surfaces (see page 15).

Bluetooth® USB Adapter

The Bluetooth USB adapter enables wireless communication between the AirLiner slate and your computer (see page 6).

NOTE: If you already have a Bluetooth USB adapter, or your computer has built-in Bluetooth wireless support, you don't have to install the Bluetooth USB adapter included with the AirLiner slate.

Rechargeable Battery

The rechargeable lithium ion battery acts as the wireless power source for the AirLiner slate (see page 6).

Power Adapter

The AirLiner slate power adapter is composed of two parts: the power supply and the power cable.

The power adapter enables you to recharge the battery and draw power to the slate from a power outlet (see page 8).

Battery-Free Tethered Pen

The battery-free tethered pen works like a mouse, enabling you to select, edit and erase objects, images and text (see page 26).

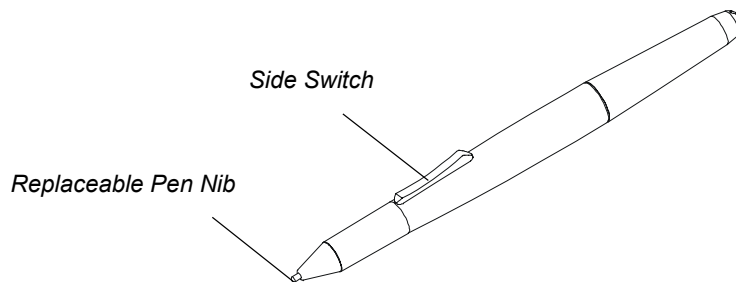

There are two customizable buttons on the pen's side switch. Press the upper or lower half of the switch to enable functions that you can customize, including right-click, middle-click, next page, previous page, start Floating Tools, start Notebook software, and more (see page 38).

CAUTION



- Do not leave the tethered pen on the slate's workspace when you aren't using it. It can interfere with pointer positioning. Instead, place the pen in the pen storage compartment or lay it flat on your desk.
- To maintain the sensitivity of your pen tip, do not store the pen so that it rests on its tip.

Cordless Mouse

The cordless mouse includes customizable left, right and wheel buttons (see page 33).

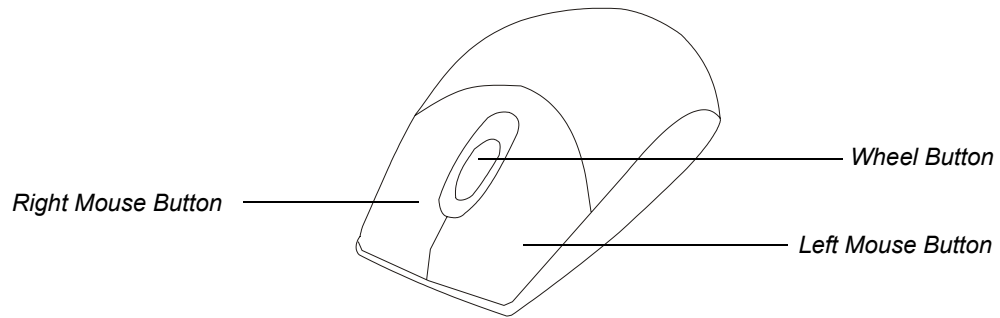

Installing the Slate

To install the AirLiner WS100 wireless slate, you must:

- Enable the wireless connection (page 6).
- Install the battery (page 6).
- Recharge the battery (page 8).
- Install the underlay (page 13).
- Install the anti-slip feet (page 15).
- Install SMART Board software on the connected computer (page 18).

Enabling the Wireless Connection

The AirLiner slate connects to your computer using Bluetooth wireless technology, which is radio-frequency technology. Therefore, the slate doesn't require a line of sight to your computer. Radio-frequency signals can pass through non-metallic objects, such as walls and bookshelves. However, interference from networks that operate in the 2.4 GHz band, devices that connect to your computer and use Bluetooth wireless technology (especially audio devices), and metallic objects in or along the line of sight can negatively impact the slate's performance and operating distance.

To work wirelessly with the AirLiner slate, install the Bluetooth USB adapter (included) on your computer using the software CD that comes with the adapter. Alternatively, you can use a computer with built-in Bluetooth wireless support, or you can purchase and install a commercially available USB-to-Bluetooth wireless adapter. If you choose to install an adapter other than the one included with your slate, purchase an adapter that complies with Bluetooth wireless specification v1.2 or higher with a Human Interface Device (HID) profile.

TIP



For best results, install the Bluetooth USB adapter included with the AirLiner wireless slate.

NOTE: The equipment described in this installation guide generates, uses, and can radiate radio-frequency energy. If the equipment isn't installed and used correctly, it can cause interference with radio and television reception.

To enable the wireless connection

If you want to install the included Bluetooth USB adapter, or if you want to purchase and install a commercially available USB-to-Bluetooth wireless adapter, install the adapter's driver software according to the instructions that came with the adapter.

IMPORTANT



- Remove previous versions of Bluetooth software before you install the software included with your Bluetooth USB adapter.
- Do not insert the Bluetooth USB adapter into a USB port until your Bluetooth software asks you to do so during the installation.
- Close any *Found New Hardware* wizards that appear during the installation (Windows® operating systems only).

If you want to use a computer with built-in Bluetooth wireless support, enable the support. For more information, see the instructions that came with your computer.

Installing the Battery

Before you can use the slate, you must install the rechargeable battery (included).

WARNING



Do not install a battery other than the one included with your AirLiner slate. Any other type of battery can damage the slate, start a fire or cause personal injury.

WARNING



If you drop the battery on a hard surface, replace the battery, even if there is no apparent damage. It may be damaged internally. Replacing the battery prevents potential damage to the slate that can occur if a damaged battery leaks after you install it.

To install the battery

1. Place the AirLiner slate upside down on a flat surface.
2. Slide open the battery compartment door.

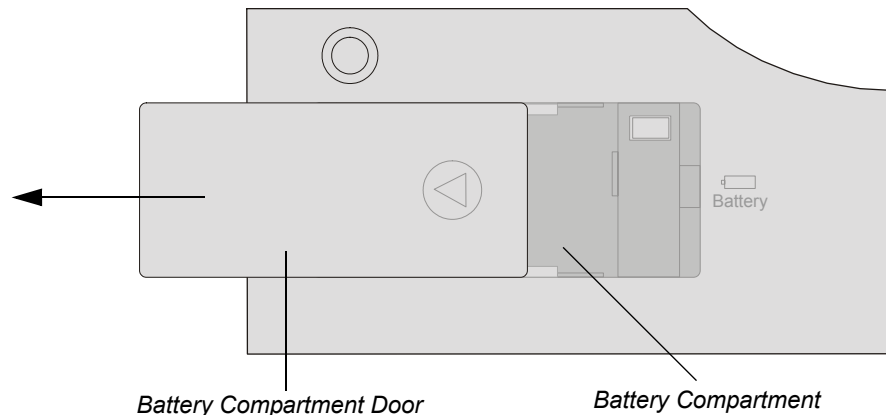

3. Insert the battery connector into its receptacle. The black wire must be closest to the slate's left edge.

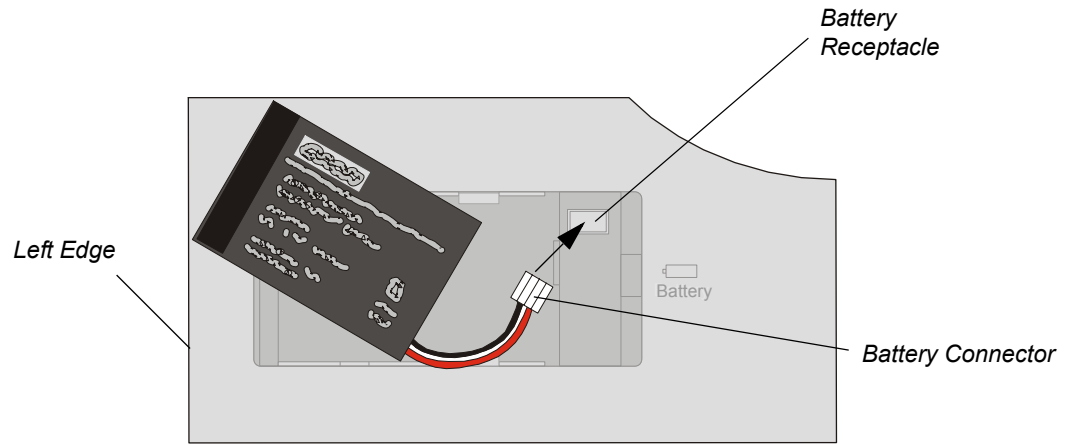

WARNING



Do not install the battery backwards or reverse its polarity. Doing so can damage the slate and can cause a fire or personal injury.

4. Push the battery into the battery compartment.

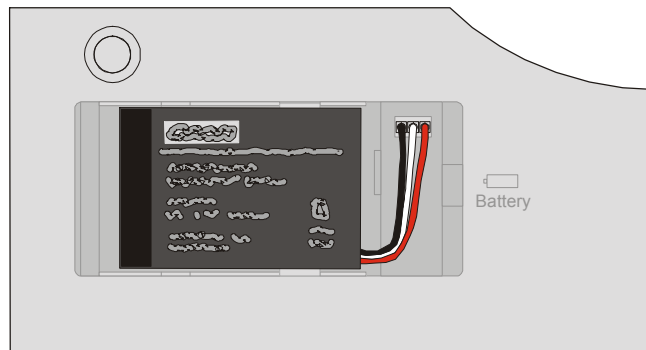

5. Close the battery compartment door.

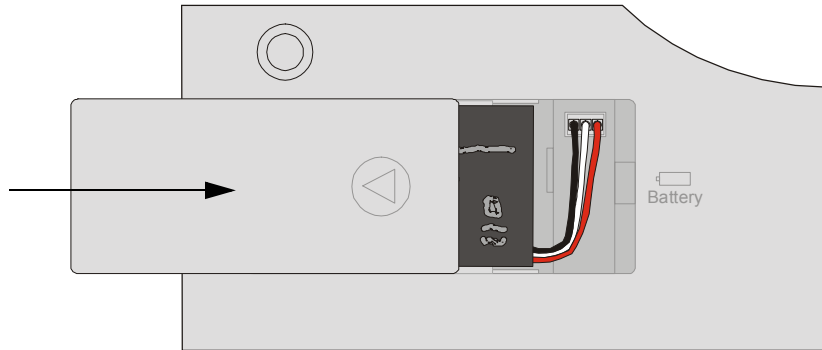

Recharging the Battery

A rechargeable lithium ion battery acts as the wireless power source for the AirLiner slate. A power adapter is included with the slate for recharging the battery and for powering the slate from a power outlet.

Before you use the slate for the first time, connect the power adapter, and then recharge the battery. You can continue installing and using the slate when the battery is recharging. A new, fully charged battery lasts for approximately 25 hours of constant use.

WARNING



Do not recharge the battery with a power adapter other than the one included with the AirLiner slate. Do not recharge other battery types in your AirLiner slate using the included power adapter. Doing so can damage the slate and can cause a fire or personal injury.

If the AirLiner slate becomes excessively warm or emits an unusual smell when the battery is recharging, immediately disconnect the power adapter from the power outlet and turn off the slate.

NOTE: The time required to fully recharge the battery varies, depending on factors such as the battery's current charge and whether the slate is in use. If the battery charge is low, it takes approximately five to six hours to fully recharge the battery.

To recharge the battery

The AirLiner slate power adapter is composed of two parts: the power supply and the power cable. Before you begin, connect the power cable to the power supply.

1. Insert the power adapter's round connector into the **DC IN** receptacle located on the right side of the AirLiner slate.

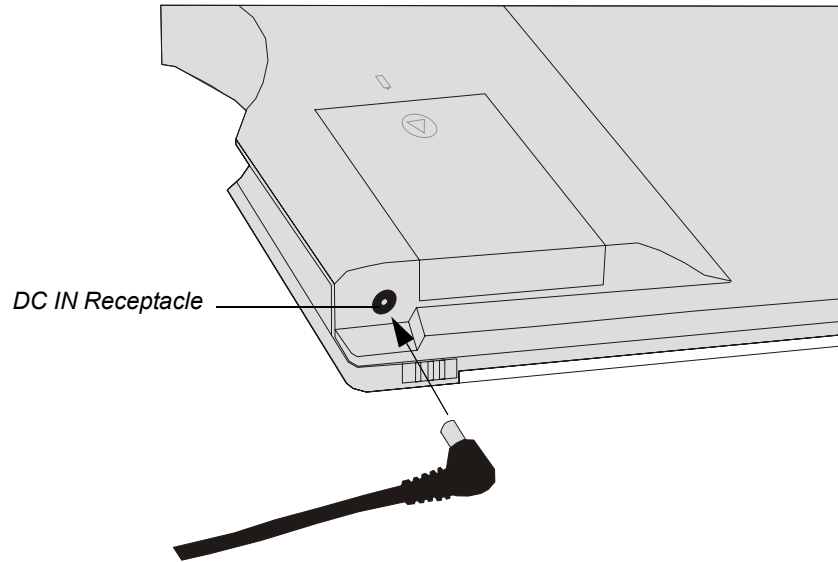

2. Insert the power adapter's pronged connector into a power outlet.

The battery starts recharging as soon as you connect the AirLiner slate to a power outlet, and the charging indicator located on the top right corner of the slate turns either green or orange. A green light indicates that the battery is fully charged, and an orange light indicates that it is recharging.

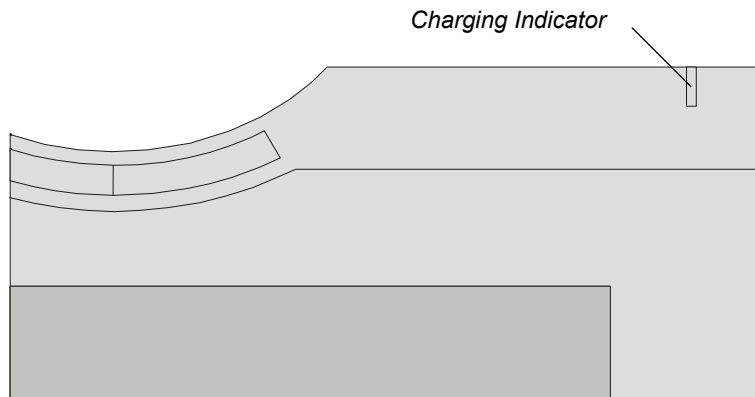

TIP



You don't have to turn on the AirLiner slate to recharge its battery.

If the charging indicator doesn't light up, the AirLiner slate isn't receiving power. Verify the following:

- The battery is correctly installed (see page 6).
- The power outlet is working.
- The power adapter cables are securely connected.
- The AirLiner slate is correctly connected to the power outlet.



IMPORTANT



If the charging indicator still doesn't light up after you verify the previous four points, the battery may be completely drained. To determine if this is the case, use the following procedure to determine the battery status.

To determine the AirLiner slate battery status (charge)

NOTE: To determine the AirLiner slate battery status, you must first install SMART Board software (see page 18).

1. Start the SMART Board software control panel:
 - Windows operating systems: Click the **SMART Board** icon  in your computer's notification area, and then select **Control Panel**.
 - Mac operating system software: Press and hold the Control key and click the **SMART Board Tools** icon  in the Dock, and then select **Open Control Panel**.
 - Linux® operating systems: Select **Applications > SMART Board Software > Control Panel**.



2. Click **SMART Board Settings**.

The *SMART Board Settings* dialog box appears.

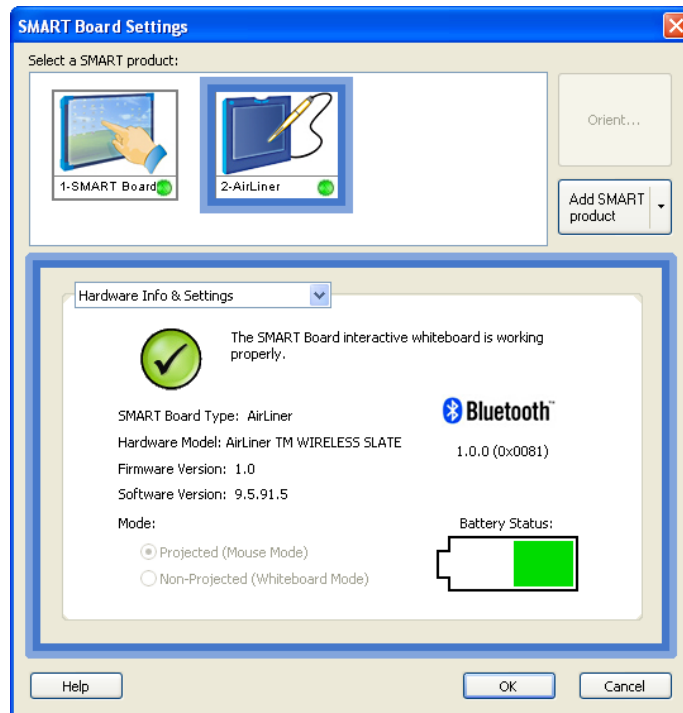
3. Click your AirLiner slate in the **Select a SMART Product** area.
A blue border appears around your AirLiner slate.



The AirLiner slate **Battery Status** is located at the bottom right corner of the *SMART Board Settings* dialog box.

	A fully green battery indicates a full charge. You can safely use the AirLiner slate wirelessly. (The battery in the previous illustration is 50% charged.)
	A partially red battery indicates a low charge. You should connect the AirLiner slate to a power outlet.
	A battery with green arrows indicates that the AirLiner slate is recharging.

If the following three issues arise, your battery is completely drained, and you must order a new one (Part No. 01-00173) from SMART Technical Support (see page 69).

- You're unable to use the AirLiner slate wirelessly after recharging the battery.
- The battery status is low (partially red) after recharging it.
- The charging indicator remains turned off when you connect the slate to a power outlet.

Tips and cautions on recharging the battery

- Turn off the AirLiner slate when you're not working with it.
- Recharge the battery to ensure that some charge remains for when you next use the slate.

NOTE: A built-in protection circuit prevents the battery from overcharging.

CAUTION



- If the AirLiner slate battery charge is low, and you will not use the slate for a few days, fully recharge the battery first.
- If you will not use the AirLiner slate for a month or longer, fully recharge the battery *and* remove it from the slate.

- Do not drain the battery's charge before you recharge it.

CAUTION



Recharge the battery as often as possible, so that it does not lose all of its charge. A battery that has lost all of its charge can no longer be recharged.

To avoid damaging the AirLiner slate battery, recharge it when the following reminders appear:

- When the battery charge falls below 20%, a notification area balloon tip appears (Windows operating systems only). You should connect the slate to a power outlet.



- When the AirLiner slate battery charge is nearly empty, the power indicator  on the slate slowly flashes blue. You must connect the slate to a power outlet before you can continue using it.

IMPORTANT



If the battery charge is nearly empty, connect the slate to a power outlet to avoid draining the battery completely. The AirLiner slate continues to draw a small amount of battery charge, even when it is turned off.

Installing the Paper Underlay

An underlay is a sheet of paper placed between the AirLiner slate's workspace and its transparent overlay. There is a tool strip of pens and icons printed on the underlay. You can press these pens and icons with the tethered pen to select customizable tools and start programs. One underlay is included with the AirLiner slate.

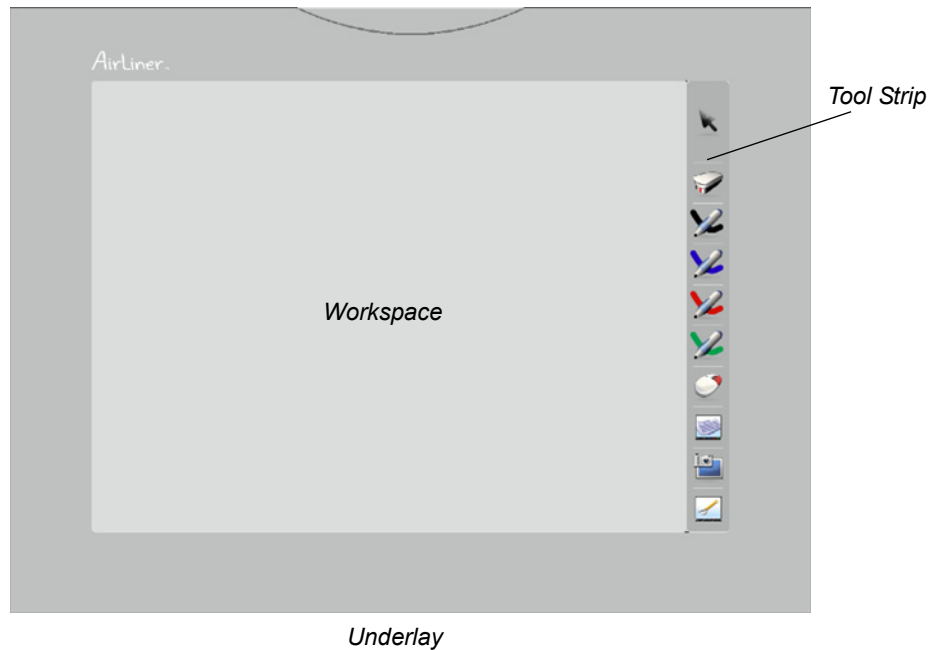

TIP



You can customize and print new underlays using the SMART Board software control panel (see page 46).

To install the underlay

1. Locate the locking slider on each side of the slate, and then slide them towards the slate's top edge.

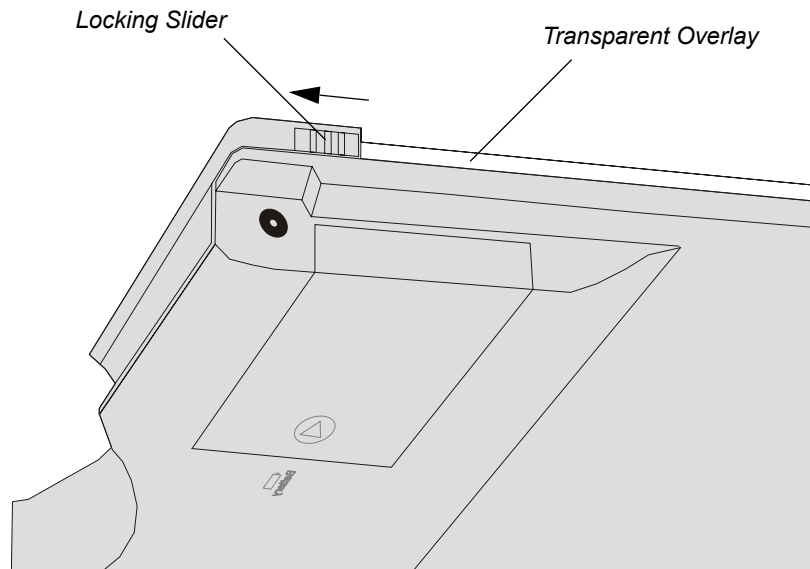

2. Grasp the transparent overlay's upper edges with your fingertips, and then lift the overlay away from the slate.
3. Place the paper underlay on the AirLiner slate.
4. Insert the plastic tabs on the overlay's lower edge into their corresponding slots on the slate, and then lower the overlay into place.
5. Slide the locking sliders towards the slate's bottom edge.

To install the adhesive anti-slip feet

Four black, adhesive anti-slip feet are included with the AirLiner slate.

1. Remove the backing paper from each anti-slip foot.
2. Place each anti-slip foot into one of the circular grooves located on the back of the AirLiner slate, and then push it firmly into the groove to secure it.

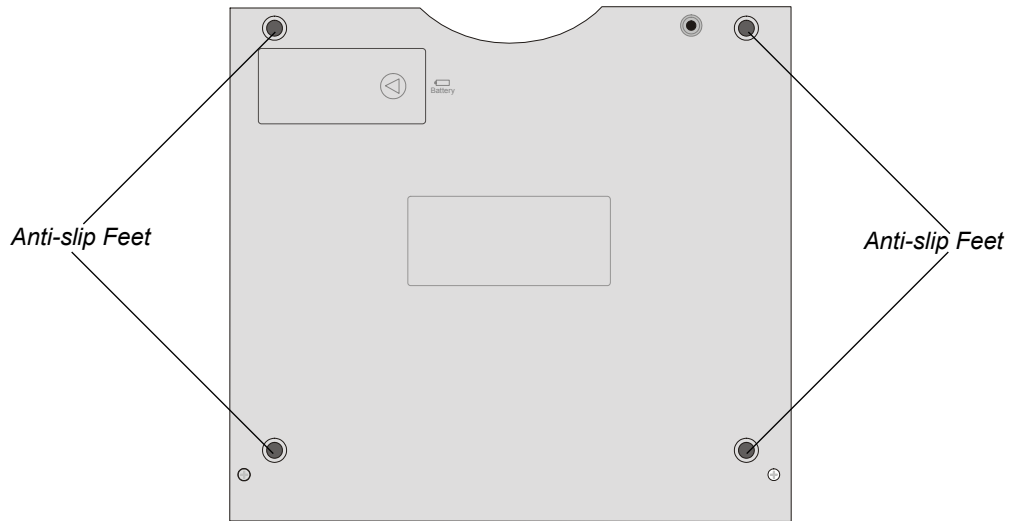

Installing the Tethered Pen

Use the tether (included) to attach the pen to the AirLiner slate, so that it's always within reach.

To attach the pen to the AirLiner slate

1. Thread one loop of the tether through the opening at the end of the pen, and then slip the rest of the tether through the loop. Pull the tether until the loop is snug.

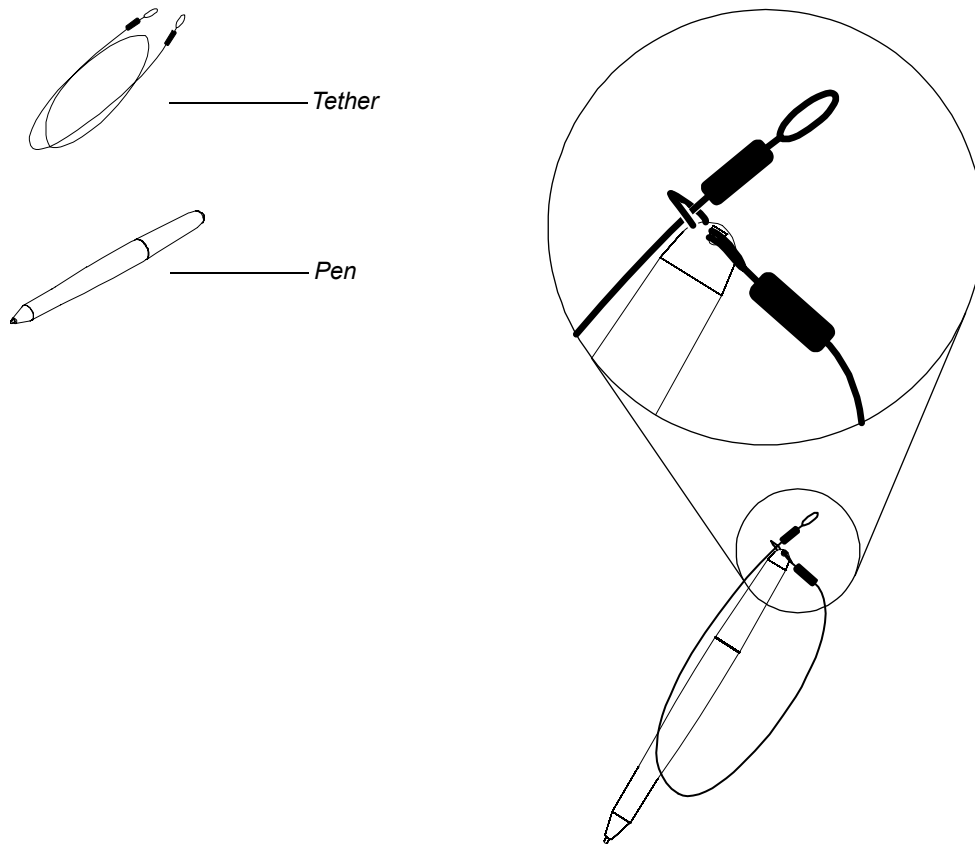

2. Thread the other loop of the tether through one of the holes located at the back of the slate.
3. Slip the pen and the rest of the tether through the loop. Pull the pen until the loop is snug.

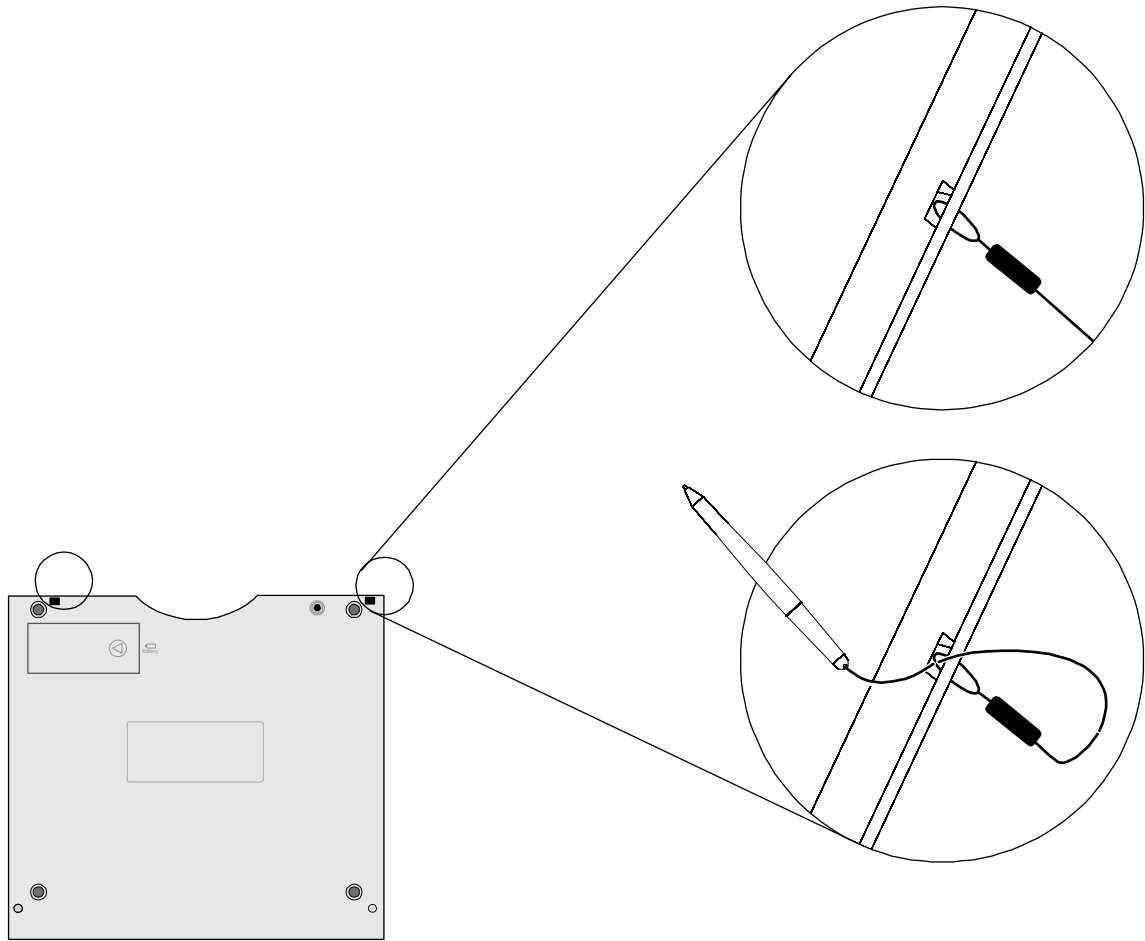

Installing SMART Board Software

To maximize your AirLiner slate's capabilities, install SMART Board software. However, if you don't install SMART Board software, you can use the slate as a mouse device.

To install SMART Board software

1. Turn on your computer and close all programs.
2. Insert the SMART Board software CD (included) in your computer's CD drive.
 - Windows operating systems: The installation starts automatically. Follow the on-screen instructions.
NOTE: If the CD doesn't start automatically, select **Start > Run**, type **x:\autorun.exe** (**x:** is your CD drive), and then press ENTER.
 - Mac operating system software: Double-click the **SMART Board Install CD** icon that appears on your desktop. A Finder window opens. Double-click the **SMART Board Software** icon, and then follow the on-screen instructions.
 - Linux operating systems: In a terminal window, locate the **/linux** installation files on the CD using the **cd** command, and then type **bash "SMART Board x.x.x.x.package"**.

NOTE: You may need an administrator's password to complete the installation.

Turning on the Slate and Creating a Wireless Connection

This chapter explains how to:

- Turn on the slate.
- Create a wireless connection between the AirLiner slate and your computer (page 19).
- Reestablish a wireless connection between the AirLiner slate and your computer (page 22).
- Disconnect the AirLiner slate from your computer (page 23).
- Turn off the slate (page 24).

Turning on the Slate

Press the power button to turn on the AirLiner slate. You can turn on the slate if it has sufficient charge in its battery or if it's connected to a power outlet.

When you turn on the slate, the power indicator (light) turns on to display the AirLiner slate's status. The power indicator encircles the power button.

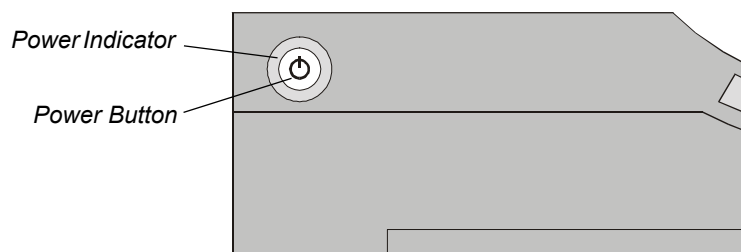

Power Indicator	Status
Solid blue	The slate is turned on, but the pen tip, side switch, mouse buttons and function buttons aren't in use.
Green	The slate is turned on, and the pen tip, a side switch, a mouse button or a function button is in use.
Slowly flashing blue	The slate is turned on, and the battery's charge is low and needs to be recharged (see page 12).
Quickly flashing blue	The slate is turned on, and the slate is in discoverable mode, attempting to establish a wireless connection with your computer (see page 21).
Off	The slate is turned off.

After you enable Bluetooth wireless support (page 5) on your computer—using either a Bluetooth USB adapter or your computer's built-in Bluetooth wireless support—you can create a wireless connection between the AirLiner slate and your computer.

Creating a Wireless Connection Between the AirLiner Slate and Your Computer

The first time you connect the AirLiner slate to a computer, you must create a wireless connection using the software included with your Bluetooth USB adapter or your computer's built-in Bluetooth wireless support.

The procedure to wirelessly connect the AirLiner slate to your computer varies, depending on whether you use a Bluetooth USB adapter or your computer's built-in Bluetooth wireless support. If you require further information, in addition to the following procedure, refer to the instructions that came with your adapter (if you're using a Bluetooth USB adapter) or your computer (if you're using your computer's built-in Bluetooth wireless support).

NOTE: The use of wireless devices is regulated in most countries. If you travel with your AirLiner wireless slate, check with the appropriate regulatory authority for information about restrictions that apply in your country of destination.

WARNING



When regulations require that wireless devices be turned off—for example, on a commercial aircraft—turn off the AirLiner slate and ensure that it cannot be accidentally turned on.

WARNING



Do not use the AirLiner slate in a facility control system or environment that requires high reliability, or where the use of wireless devices can cause interference. The slate can interfere with, or cause, other electronic devices to malfunction, and other wireless devices can interfere with, or cause, the AirLiner slate to malfunction.

Where its use is prohibited, turn off the slate to prevent it from interfering with other electronic devices or causing other electronic devices to malfunction. SMART Technologies does not accept liability for direct or consequential damages.

To create a wireless connection between the AirLiner slate and your computer

IMPORTANT • The first time you create a connection between the AirLiner slate and your computer, it is helpful to position the slate as close to your computer as possible and to ensure that there is a direct, unobstructed line of sight between the slate and your Bluetooth USB adapter or built-in Bluetooth wireless support.

- Move or turn off equipment such as microwave ovens and cordless telephones, because they can interfere with Bluetooth wireless technology.



1. Enable your wireless connection (see page 5).
2. Press the **Connect** button.

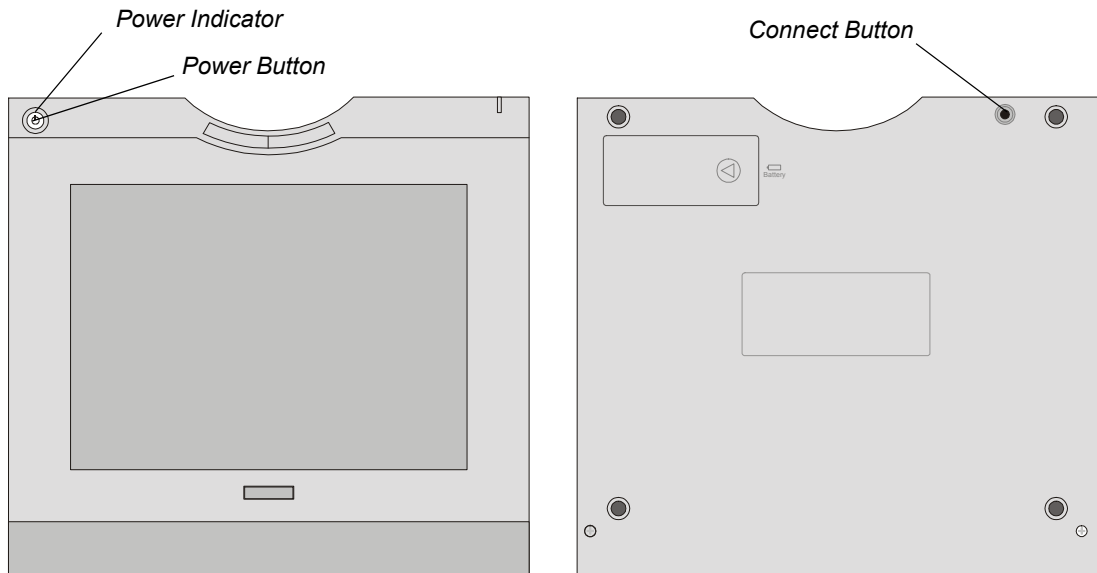

The power indicator flashes quickly, indicating that the AirLiner slate is in discoverable mode and allowing your computer to detect it in the following steps. When the slate is in discoverable mode, the power indicator flashes for three minutes or until the slate can establish a wireless connection with your computer.

NOTE: You can only create a wireless connection between the slate and your computer when the slate is in discoverable mode.

3. Select the device setup option in your Bluetooth software, and then follow the on-screen instructions.
 - If asked to specify a service for the device, select the AirLiner slate service or Human Interface Device service; otherwise, select the mouse device service.
 - When asked to select your device, select the mouse icon labeled **SMART Wireless Slate**. Alternatively, the AirLiner slate may be labeled a mouse device. If this is the case, select the mouse device.
- NOTE:** If your computer doesn't detect the AirLiner slate, repeat step 2.
- If asked to specify an authentication code or passkey, select the non-affirmative option (e.g., the **Don't Use** or **No** option). The AirLiner slate doesn't require passkey authentication.

IMPORTANT

After you successfully create a wireless connection between the AirLiner slate to your computer, the slate appears as a connected device in your Bluetooth software, and the power indicator on the slate turns solid blue.

To confirm a successful connection to your computer, write with the tethered pen on the slate's workspace. The pointer's on-screen movement should reflect the pen's movement on the slate.

NOTE: If you're unable to create a wireless connection within three minutes of pressing the connect button, the slate automatically turns off.

After you create a connection between the AirLiner slate and your computer, the slate rejects connection attempts by other computers. However, if you press the **Connect** button, the slate switches to discoverable mode, allowing you to create a new wireless connection.

TIP

The AirLiner slate remains connected to your computer until you create a new wireless connection with another computer. Therefore, if you restart your computer or temporarily remove the Bluetooth USB adapter, the slate maintains its connection to your computer. You don't need to press the **Connect** button on your AirLiner slate again.

Only press the **Connect** button if you want to connect the AirLiner slate to a another computer. If you press the **Connect** button, you break the slate's current connection to your computer, and you must create a new wireless connection by following steps 2 and 3 in the previous procedure.

Reestablishing the Wireless Connection

The AirLiner slate automatically reestablishes a wireless connection to your computer after you create a wireless connection the first time, even if you restart your computer or temporarily remove the Bluetooth USB adapter. However, you must create a new wireless connection between the AirLiner slate and your computer (page 20) in the following situations:

- You press the **Connect** button.
- You create a wireless connection with a second computer, and then return to the first computer.

The AirLiner slate turns off when its wireless connection to your computer is broken for more than two seconds. You can reestablish the wireless connection *without* pressing the **Connect** button in these instances:

- You turn off the connected computer.
- You remove the Bluetooth USB adapter from the computer's USB port.
- You turn off the computer's built-in Bluetooth wireless support.
- You move the slate outside the operational range of the Bluetooth wireless connection.

NOTE: To determine the operational range of your wireless connection, see the instructions included with your adapter (if you're using a Bluetooth USB adapter) or your computer (if you're using your computer's built-in Bluetooth wireless support).

To reestablish the wireless connection

1. Reset the device that caused the broken connection:
 - Turn on the computer.
 - Insert the Bluetooth USB adapter into your computer's USB port.
 - Turn on your computer's built-in Bluetooth wireless support.
 - Move the slate within the operational range of the Bluetooth wireless connection.
2. Press the slate's power button.

The slate automatically reestablishes its most recent wireless connection.

To confirm a successful connection to your computer, write with the tethered pen on the slate's workspace. The pointer's on-screen movement should reflect the pen's movement on the slate.

Disconnecting the AirLiner Slate from Your Computer

If you want to connect the AirLiner slate to another computer, you must first disconnect it from the current computer. You can disconnect the slate using either the slate or the computer.

To disconnect the AirLiner slate using the slate

Press the **Connect** button on the back of the slate.

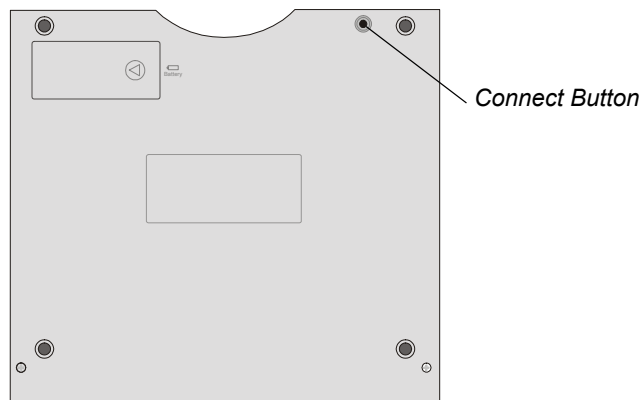

When you press the **Connect** button, the slate switches to discoverable mode, and you can connect it to another computer (see page 21).

To disconnect the AirLiner slate using the computer

1. Open the control panel for your Bluetooth wireless device.
2. Open the list of devices that your computer connects to using Bluetooth wireless technology.
NOTE: The procedure required to open the list of wireless connections varies, depending on whether you're using a Bluetooth USB adapter or your computer's built-in Bluetooth wireless support, and depending on your operating system. Some Bluetooth software control panels display the connected devices in a list, and others display the devices as icons.
3. Select the AirLiner slate connection, and then delete it.

Turning off the Slate

To turn off the slate, press the power button or allow the slate to turn off automatically.

The slate turns off automatically in the following circumstances:

- The slate doesn't establish a connection with a computer within three minutes of pressing the **Connect** button.
- The slate's wireless connection to your computer is broken for two seconds or more.
- The battery's charge falls below operational level, and the slate isn't connected to an external power supply (page 12).

Using the Slate and its Tools

This chapter describes how to use the AirLiner slate's tools:

- the battery-free tethered pen (page 26)
- the cordless mouse (page 33)
- the function buttons (page 34)
- the slate locking feature (page 34).

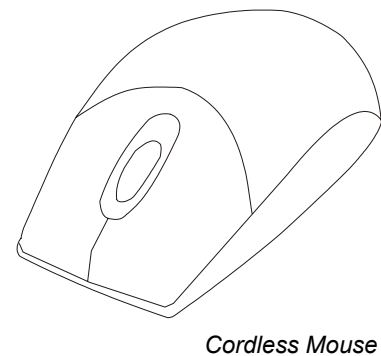
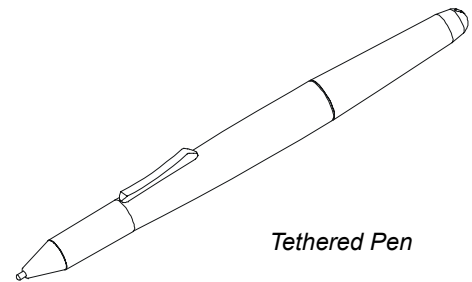
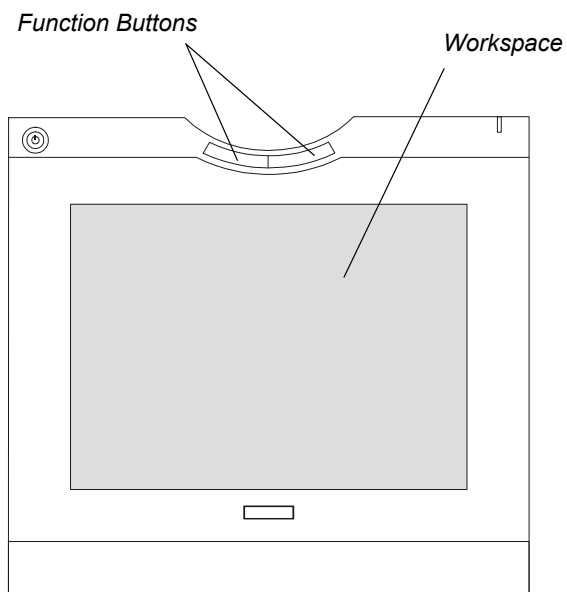

Using the Battery-Free Tethered Pen

Within the slate's workspace, you can use the tethered pen to point, single-click, double-click, select creative tools, start programs, and more. You can also customize the side switch. Use the tethered pen in place of a mouse device.

When you aren't using the tethered pen, place it in the storage compartment, so that it's easily accessible for later use.

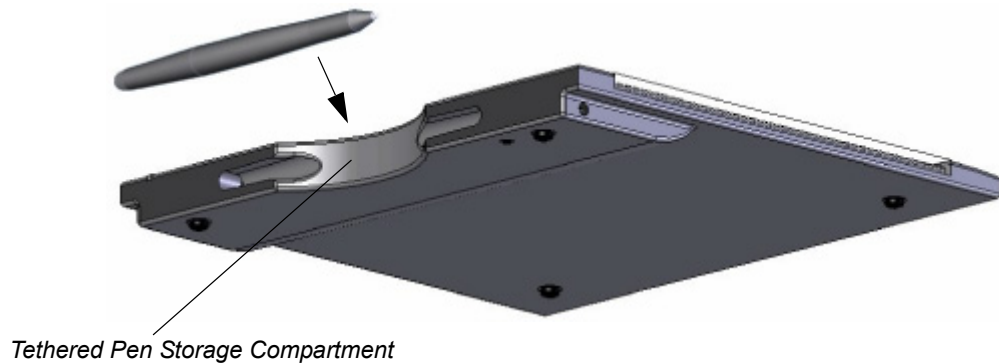

CAUTIONS



- Do not leave the tethered pen on the slate's workspace when you are not using it. It can interfere with pointer positioning.
- To maintain the sensitivity of your pen tip, do not store the pen so that it rests on its tip.

To hold the tethered pen

Hold the tethered pen like you hold a pen or pencil, and hold it as perpendicular to the slate as possible. Hold it so that you can conveniently press the side switch with your thumb or forefinger, but won't accidentally press it.

To point on the display

The AirLiner slate's workspace is a mapped representation of your display, be it your computer screen, SMART Board interactive whiteboard or Sympodium interactive pen display. Each point on the workspace corresponds to a point on your display. When you move the pen on the slate's workspace, the pointer moves along the corresponding points on your display.

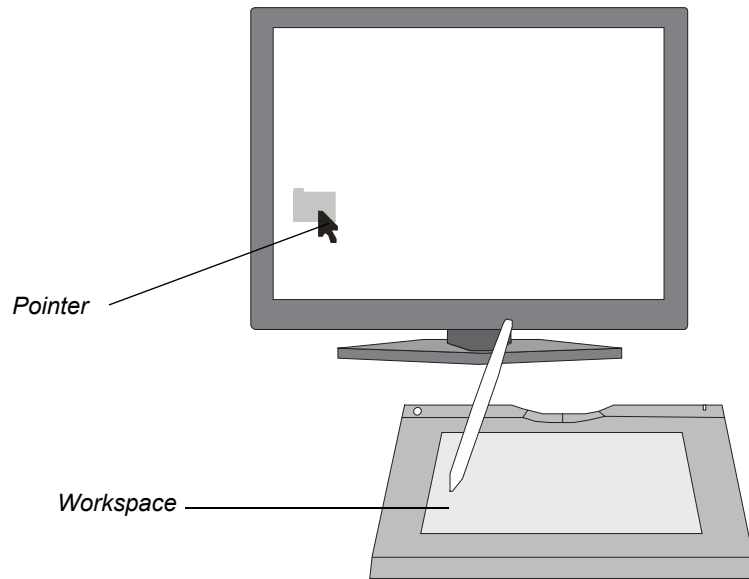

By default, the Enable Hover feature is selected, allowing you to move the pointer on your display and engage the side switch without touching the slate. You can hover the pen within 1/4" (6.5 mm) of the slate's surface to move your display's pointer and engage the side switch.



TIP



If you're not accustomed to working with the tethered pen, you can practice the hand-eye coordination exercise on page 32.

To select or clear the Enable Hover feature

NOTE: To select or clear the Enable Hover feature, you must first install SMART Board software (see page 18).

1. Start the SMART Board software control panel:
 - Windows operating systems: Click the **SMART Board** icon  in your computer's notification area, and then select **Control Panel**.
 - Mac operating system software: Press and hold the Control key and click the **SMART Board Tools** icon  in the Dock, and then select **Open Control Panel**.
 - Linux operating systems: Select **Applications > SMART Board Software > Control Panel**.
2. Click **SMART Board Settings**.

The *SMART Board Settings* dialog box appears.
3. Click your AirLiner slate in the **Select a SMART product** area.

A blue border appears around your AirLiner slate.
4. Select **Mouse Settings** from the list.
5. Select or clear the **Enable Hover** check box.

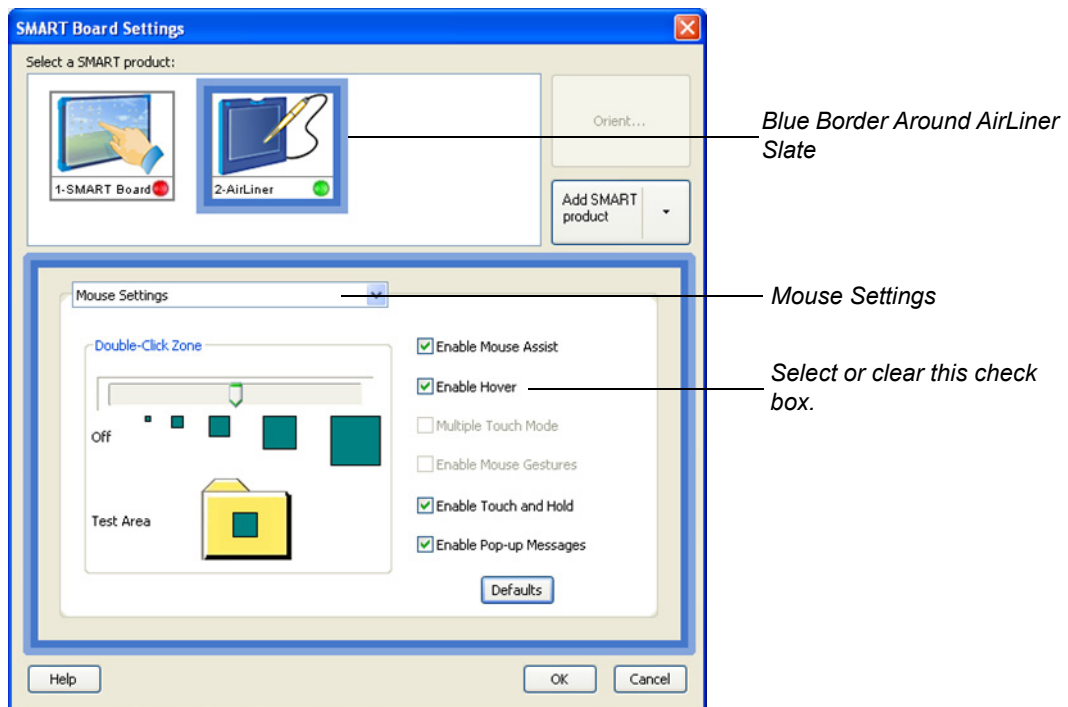

To click with the tethered pen

To replicate a single-click on a mouse, tap the pen tip once on the workspace.

To double-click with the tethered pen

To replicate a double-click on a mouse, quickly tap the pen tip twice in the same place on the workspace.

NOTE: You can increase the Double-Click Zone on the workspace, in order to give yourself more leeway when double-clicking (see page 37). When you select a large Double-Click Zone, you don't have to tap the pen twice in exactly the same place.

To drag an object from one area of the display to another

1. Position the pointer on the object you want to move.
2. Press the pen tip on the workspace.
3. Slide the pen across the workspace, dragging the object to the desired area of your display.
4. Lift the pen.

The object appears in the area of your display that you dragged it to.

To select text

1. Position the pointer at the beginning of the text you want to select.
2. Press the pen tip on the workspace.
3. Slide the pen across the workspace until the desired text is highlighted.
4. Lift the pen.

To use the side switch

Pressing the side switch as you move the tethered pen on the workspace changes the pen's function.

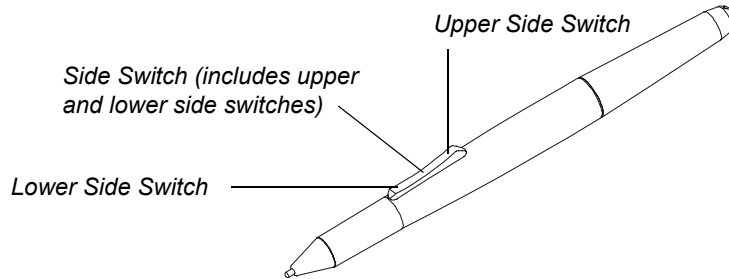



1. Press and hold the upper or lower side switch, depending on the tool you want to apply.
2. Position the pointer at the desired location of your display.
3. Press the pen tip on the workspace, and then move it in the desired manner.

NOTE: You can customize both the upper and lower side switches on the tethered pen (see page 38). By default, the upper side switch is set to the eraser tool, and the lower side switch is set to the black pen tool.

To use the tool strip

You can press the underlay's tool strip icons (adjacent) with the tethered pen to select creative tools, start programs and change the pen's function. By default, you can select the following tool strip icons: pointer, eraser, black pen, blue pen, red pen, green pen, right-click, on-screen keyboard, screen capture and SMART Board software control panel. However, you can customize and print underlays and tool strip icons (see page 46).



- By default, the tethered pen assumed the pointer function  .
- If you press a program button, such as the SMART Board software control panel  , the program automatically starts.
- If you press a creative tool button, such as the red pen tool  , position the tethered pen at the desired location of your display, press the pen tip on the workspace, and then write or draw like you would with an ink pen on paper.

To write in digital ink

You can select a creative tool on the tool strip (adjacent) or by pressing the tethered pen's side switch, and then write or draw on the AirLiner slate's workspace with digital ink. Digital ink mimics the appearance of liquid ink on paper. Creative tools include colored pens, highlighters and stamps.

You can write with digital ink anywhere on your display, and you also can save what you write and draw as part of the program file you're working with or as a separate screen capture file. See the SMART Board software online Help for more information.

NOTE: To work with digital ink, you must first install SMART Board software on your computer (see page 18).

To write with digital ink using a creative tool on the tool strip

1. Press the tethered pen on a creative tool (e.g., a pen, highlighter or stamp) on the tool strip, and then release it.
2. Position the pointer at the desired location of your display.
3. Press the pen tip on the workspace, and then write or draw like you would with an ink pen.

To write with digital ink using the side switch

1. Press and hold the upper or lower side switch (depending on how you customize the switch).
NOTE: By default, the lower side switch is set to the black pen tool.
2. Position the pointer at the desired location of your display.
3. Press the pen tip on the workspace, and then write or draw like you would with an ink pen.

To erase digital ink

You can use the tethered pen to erase digital ink on your display. There are two ways you can do this: using the eraser tool strip icon or using the side switch.

By default, the upper side switch is set to the eraser tool; however, you can customize it to suit your needs (see page 38). You can also customize and print underlays and tool strip icons (see page 46).

To use the eraser tool strip icon to erase

1. Press the tethered pen on the eraser tool strip icon  , and then release it.
2. Position the pen at the desired location of your display.
3. Press the pen tip on the workspace, and then move it over the digital ink you want to erase.



To use the side switch to erase

1. Press and hold the upper or lower side switch (depending on how you customize the switch)
2. Position the pointer at the desired location of your display.
3. Press the pen tip on the workspace, and then move it along the digital ink you want to erase.

To practice hand-eye coordination

The following exercise is designed to improve hand-eye coordination, a skill that will help you work with the tethered pen.

1. Open Notebook software or a graphics program.
2. Select a line tool, and then draw a rectangular grid with line spacings of about 3/4" (2 cm).
3. Select a free-hand tool, and then draw a dot at each grid intersection.
4. Draw an X at each grid intersection.
5. Draw a circle around each grid intersection.

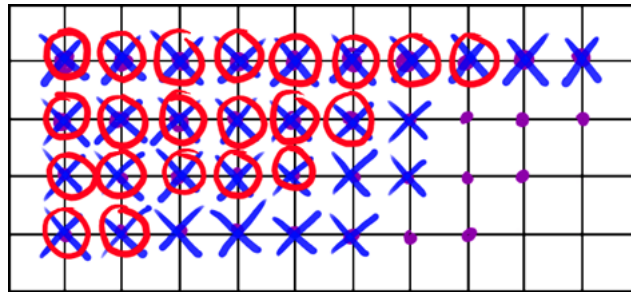

TIP



Practice drawing with the pen. The more you use the pen, the easier and more natural it becomes to work with.

Using the Cordless Mouse

The cordless mouse is battery-free. You can use it like a traditional mouse within the workspace, instead of the tethered pen.

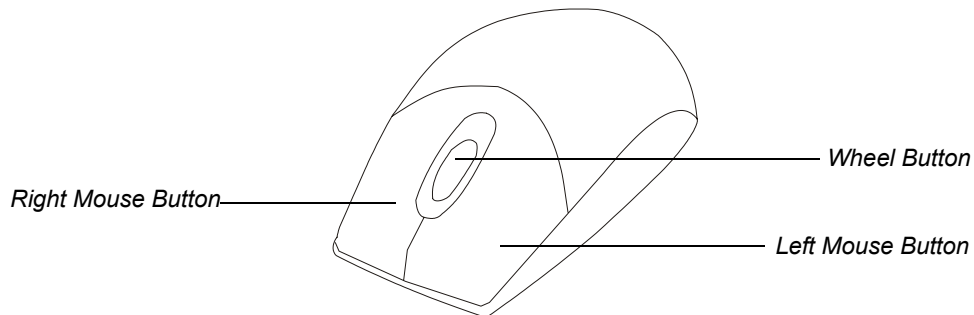

The cordless mouse has three buttons. The left mouse button is set to left-click, the right mouse button is set to right-click, and the wheel button is set to middle-click. In many programs, you can rotate the wheel button to scroll up and down.

Because the cordless mouse works like a traditional mouse, you can customize its buttons in your operating system software. You can also use the cordless mouse to write in digital ink on your display, in place of the tethered pen.

TIP



In Microsoft® Office programs that support mouse devices with wheel buttons, press and hold the CTRL key, and then rotate the wheel button to zoom in and out of the current program window.

CAUTION



Do not leave the cordless mouse on the slate's workspace when you are not using it, because it can interfere with pointer positioning.

To write with digital ink using the cordless mouse

NOTE: To work with digital ink, you must first install SMART Board software on your computer (see page 18).

1. Press the tethered pen on a creative tool (e.g., a pen, highlighter or stamp) on the tool strip, and then release it.
2. Place the tethered pen in its storage compartment, and then place the cordless mouse on the workspace.
3. Position the pointer at the desired location of your display.
4. Press and hold the left mouse button, and then write or draw like you would with an ink pen.

Using the Function Buttons

There are two customizable function buttons located at the top of the AirLiner slate. By default, the left function button is set to start Floating Tools, and the right function button is set to start Notebook software. However, you can customize the function buttons to suit your needs (see page 44).

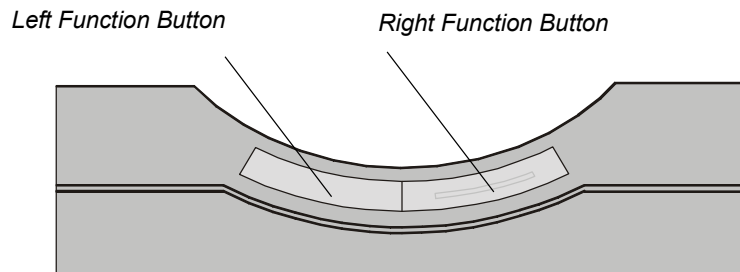



Locking the AirLiner Slate

You can lock AirLiner wireless slates from interacting with the connected display, be it a computer screen, SMART Board interactive whiteboard or Sympodium interactive pen display. You may, for example, choose to do this in a classroom environment where you want to control when students can interact with the interactive whiteboard.

To lock and unlock AirLiner slates using the tool strip

You can lock and unlock AirLiner slates using a customized tool strip button if there are two or more connected AirLiner slates.

- To lock all *other* AirLiner slates, press the **Lock AirLiners** button  on the tool strip. (See page 46 to learn how to add the **Lock AirLiners** button to the tool strip.)
- To unlock all other AirLiner slates, press the **Lock AirLiners** button  again.

NOTE: Only the person who locks all other AirLiner slates using the **Lock AirLiners** tool strip button can unlock them the same way.

You can also unlock AirLiner slates that have been locked using the underlay's tool strip by following either of the two following unlocking methods.



To lock and unlock AirLiner slates using the SMART Board icon

Windows and Linux operating systems

- To lock all AirLiner slates, click the **SMART Board** icon  in your computer's notification area, and then select **Other SMART Tools > Lock Airliners**.

The **AirLiners Locked** floating tool appears.



- To unlock all AirLiner slates, click the **SMART Board** icon  in your computer's notification area, and then select **Other SMART Tools > Unlock Airliners**.

OR

To unlock all AirLiner slates, click the **AirLiners Locked** floating tool.

Mac operating system software

- To lock all AirLiner slates, press and hold the Control key and click the **SMART Board** icon  in the Dock, and then select **Lock AirLiners**.

The **AirLiners Locked** floating tool appears.

- To unlock all AirLiner slates, press and hold the Control key and click the **SMART Board** icon  in the Dock, and then select **Unlock AirLiners**.

OR

To unlock all AirLiner slates, click the **AirLiners Locked** floating tool.



To lock and unlock AirLiner slates using the SMART Board software Start Center

- To lock all AirLiner slates, click the **Lock AirLiners** button  in the SMART Board software Start Center (adjacent).

The **AirLiners Locked** floating tool appears.

- To unlock all AirLiner slates, click the **Unlock AirLiners** button  in the SMART Board software Start Center (adjacent).

OR

To unlock all AirLiner slates, click the **AirLiners Locked** floating tool.

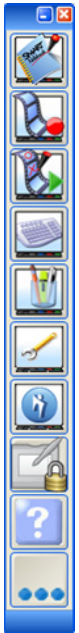

NOTE: To add the **Lock AirLiners** button  to the SMART Board software Start Center, see the SMART Board software online Help.

Customizing the Slate

This chapter describes how to customize the AirLiner slate and its tools:

- Customize the tethered pen (this page).
- Customize the function buttons (page 44).
- Customize and print underlays (page 46).
- Map pointer movement to multiple displays (page 51).



NOTE: To customize the AirLiner slate and its tools, you must first install SMART Board software (see page 18).

Customizing the Tethered Pen

You can customize the tethered pen by adjusting the Tip Feel and changing the side switch functions.

To adjust the Tip Feel

Tip Feel refers to the amount of pressure you need to apply on the workspace in order to select text, select tool strip icons and write with digital ink.

1. Start the SMART Board software control panel:
 - Windows operating systems: Click the **SMART Board** icon  in your computer's notification area, and then select **Control Panel**.
 - Mac operating system software: Press and hold the Control key and click the **SMART Board Tools** icon  in the Dock, and then select **Open Control Panel**.
 - Linux operating systems: Select **Applications > SMART Board Software > Control Panel**.
2. Click **SMART Board Settings**.

The *SMART Board Settings* dialog box appears.
3. Click your AirLiner slate in the **Select a SMART product** area.

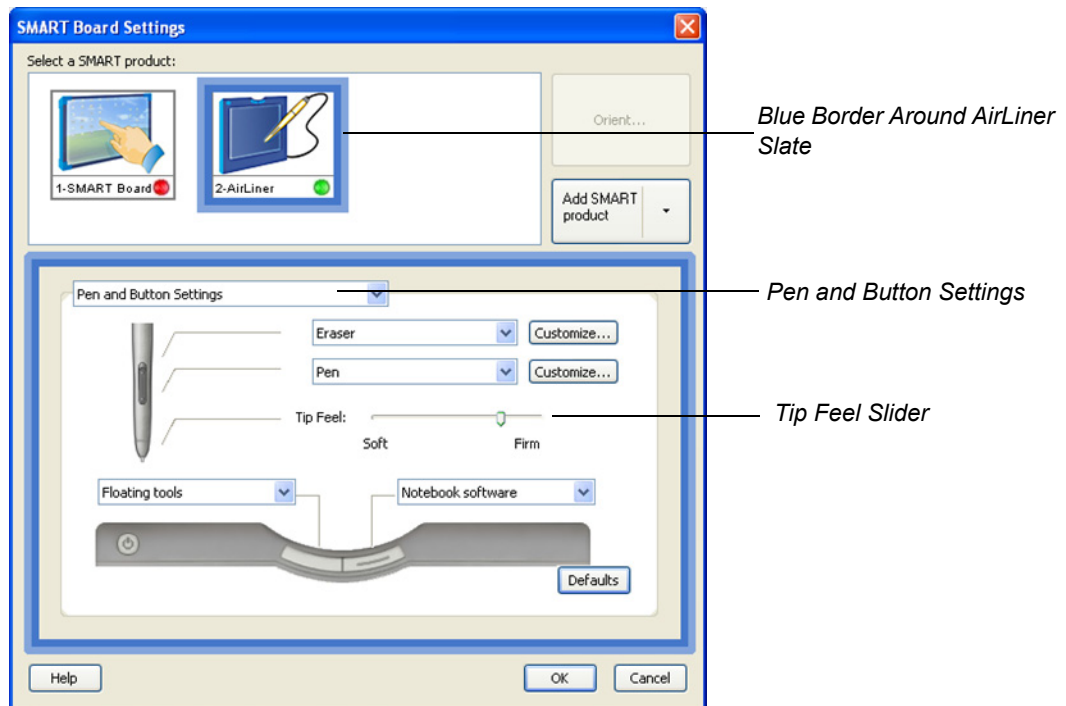

A blue border appears around your AirLiner slate.
4. Select **Pen and Button Settings** in the list.

5. Move the **Tip Feel** slider to the desired level. Select a firm Tip Feel if you want to apply a lot of pen tip pressure on the workspace, or select a soft Tip Feel if you want to apply minimal pen tip pressure on the workspace.



6. Click **OK**.
The *SMART Board Settings* dialog box closes.
7. Close the SMART Board software control panel.

To customize the side switch

1. Start the SMART Board software control panel:
 - Windows operating systems: Click the **SMART Board** icon  in your computer's notification area, and then select **Control Panel**.
 - Mac operating system software: Press and hold the Control key and click the **SMART Board Tools** icon  in the Dock, and then select **Open Control Panel**.
 - Linux operating systems: Select **Applications > SMART Board Software > Control Panel**.
2. Click **SMART Board Settings**.
The *SMART Board Settings* dialog box appears.
3. Click your AirLiner slate in the **Select a SMART product** area.
A blue border appears around your AirLiner slate.

4. Select **Pen and Button Settings** in the list.

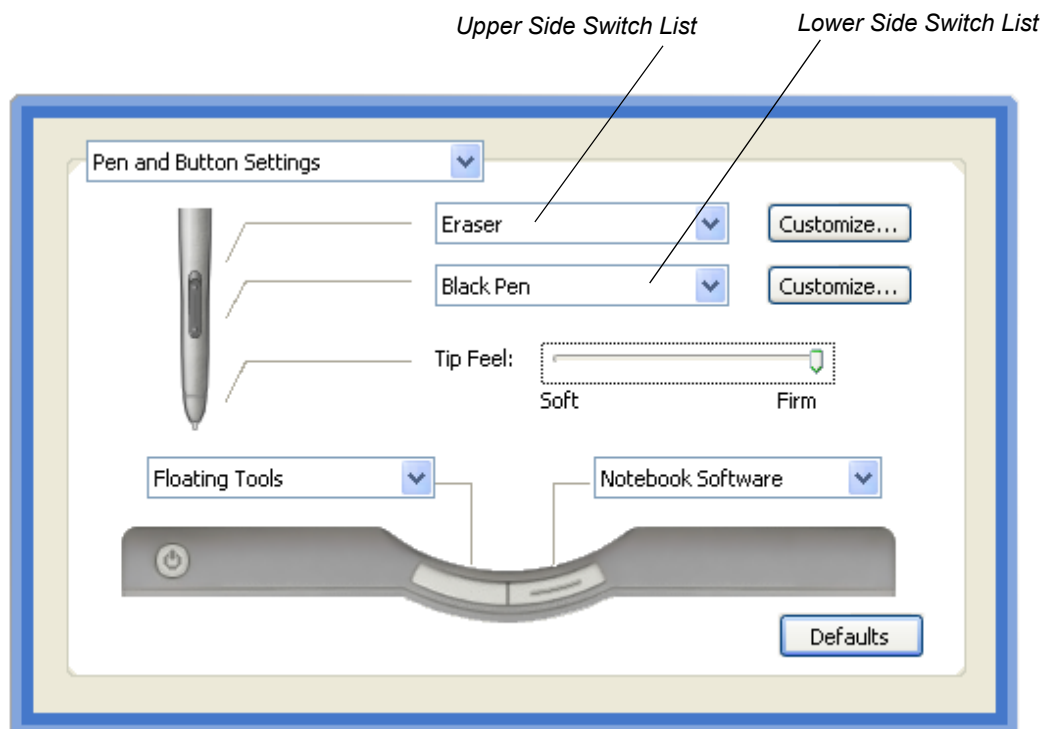
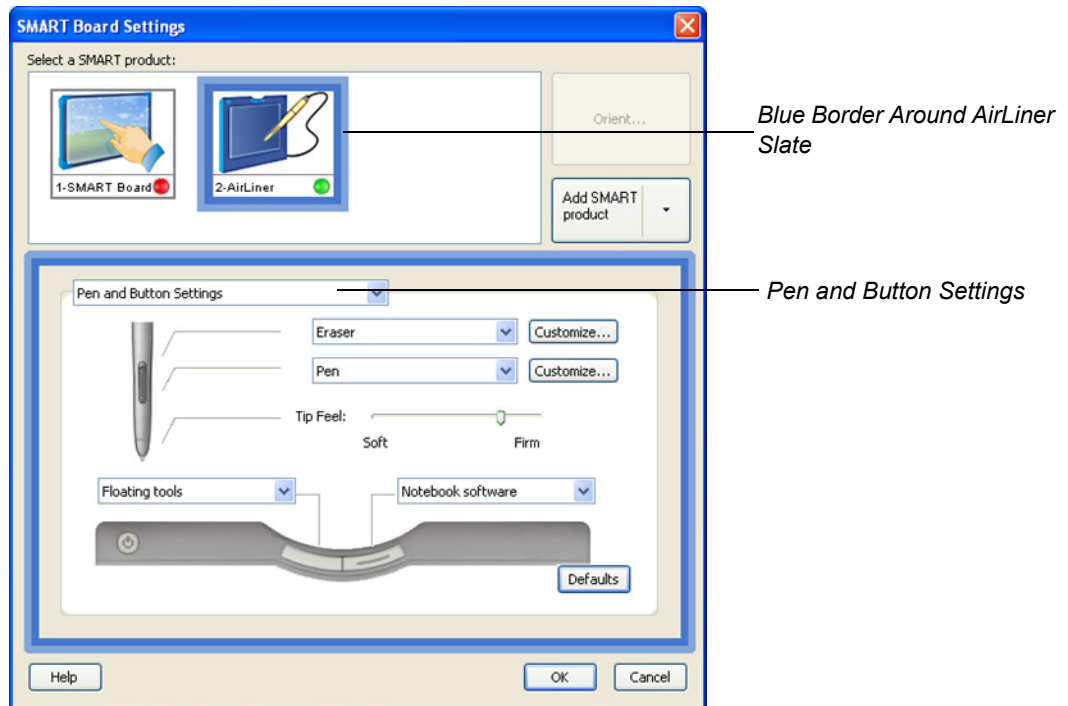

5. Select the desired functions in the upper and lower side switch lists.

Side Switch List Item	Side Switch Function
Print page	Print the current page in Notebook software.
Next page	Go to the next page in Notebook software.
Previous page	Go to the previous page in Notebook software.
Clear screen	Clear the current page in Notebook software.
Right-click	Right-click. NOTE: This is the default setting for the right mouse button.
Middle-click	Middle-click. NOTE: This is the default setting for the mouse wheel button.
Floating mouse	Prevent clicking and double-clicking with the pen. NOTE: This function doesn't apply to the AirLiner slate. You can select it for other SMART products.
Keyboard	Start the on-screen keyboard.
Floating tools	Start Floating Tools. NOTE: This is the default setting for the left function button.
Notebook software	Start Notebook software. NOTE: This is the default setting for the right function button.
Screen capture toolbar	Start the screen capture tools.
Pen	Set the pen to function like a creative tool. NOTE: This is the default setting for the lower side switch.
Eraser	Set the pen tip to behave like an eraser. NOTE: This is the default setting for the upper side switch.
Disabled	Don't attribute a function to the side switch.

6. If you select **Pen** or **Eraser** in the list, click **Customize**.

The *Customize Pen* dialog box appears.

OR

The *Customize Eraser* dialog box appears.

- a. Select attributes for your pen in the **Outline Color**, **Line Properties** and **Transparency** areas.

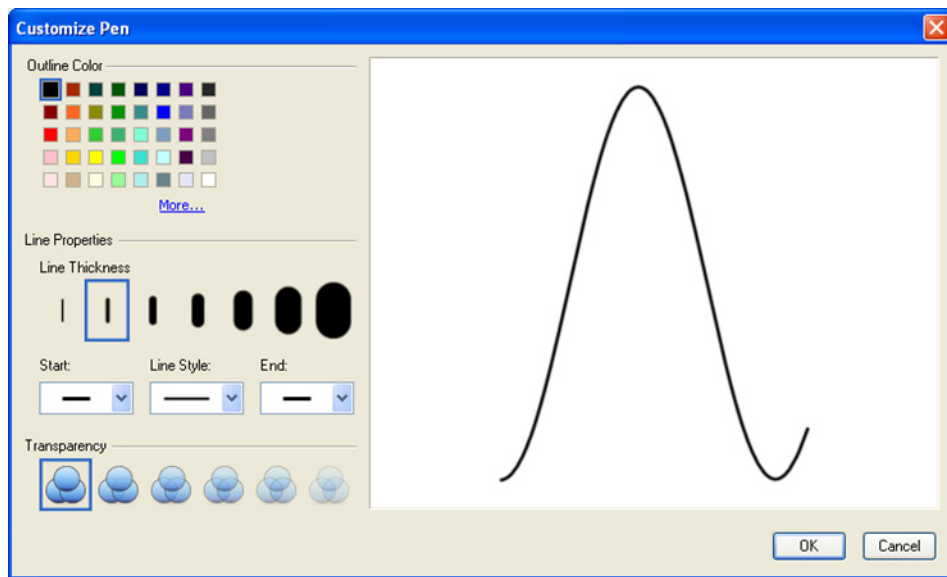

OR

Click an eraser icon to select the desired eraser thickness.

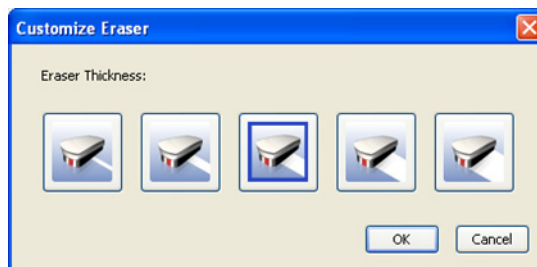

- b. Click **OK**.



The *Customize Pen* dialog box closes.

OR

The *Customize Eraser* dialog box closes.



7. Click **OK**.
The *SMART Board Settings* dialog box closes.
8. Close the SMART Board software control panel.

To customize Mouse Settings for the tethered pen

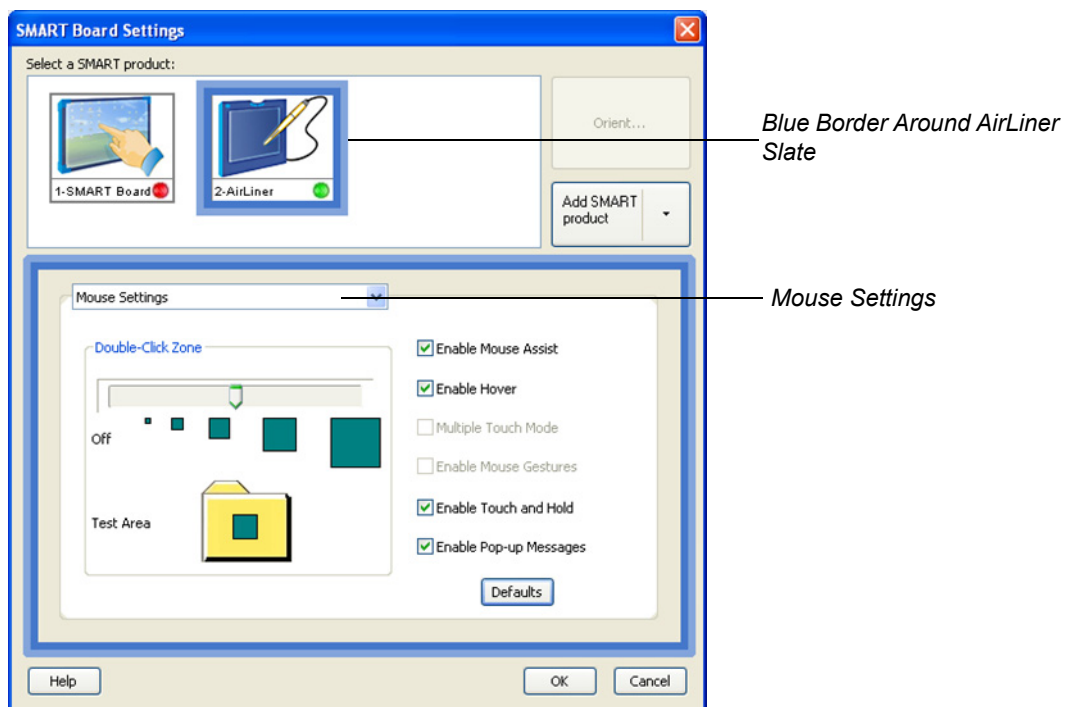
1. Start the SMART Board software control panel:
 - Windows operating systems: Click the **SMART Board** icon  in your computer's notification area, and then select **Control Panel**.
 - Mac operating system software: Press and hold the Control key and click the **SMART Board Tools** icon  in the Dock, and then select **Open Control Panel**.
 - Linux operating systems: Select **Applications > SMART Board Software > Control Panel**.
2. Click **SMART Board Settings**.
The *SMART Board Settings* dialog box appears.
3. Click your AirLiner slate in the **Select a SMART product** area.
A blue border appears around your AirLiner slate.
4. Select **Mouse Settings** in the list.



- Select your mouse settings.



Setting	Function
Double-Click Zone	Double-Click Zone allows you to set a greater margin of error when double-clicking. When you select a large Double-Click Zone, you don't have to tap the tethered pen twice in exactly the same place.
Enable Mouse Assist	Mouse Assist makes it easier to move the pointer to commonly used buttons and toolbars, such as close buttons  and scroll bar buttons  .
Enable Hover	Enable Hover allows you to move the pointer on your display and engage the side switch without touching the slate. See page 28 for more information.
Enable Touch and Hold	Touch and Hold is another way to right-click. Press and hold the tethered pen on the workspace to right-click.
Enable Pop-up Messages	<p>Pop-up Messages appear in your Internet browser if you select this option; otherwise, they are blocked.</p> <p>This is not a mouse-specific setting.</p> <p>NOTES</p> <ul style="list-style-type: none"> If you clear this check box to prevent pop-up message disruptions during a lesson or presentation, it's a good idea to select it again when you're done, because pop-up messages are often important and helpful. You can also configure pop-up message settings in your operating system software.

- Click **OK**.
The *SMART Board Settings* dialog box closes.
- Close the SMART Board software control panel.

Customizing the Function Buttons

By default, the left function button starts Floating Tools, and the right function button starts Notebook software. However, you can change the functions of these buttons.

To customize the function buttons

1. Start the SMART Board software control panel:
 - Windows operating systems: Click the **SMART Board** icon  in your computer's notification area, and then select **Control Panel**.
 - Mac operating system software: Press and hold the Control key and click the **SMART Board Tools** icon  in the Dock, and then select **Open Control Panel**.
 - Linux operating systems: Select **Applications > SMART Board Software > Control Panel**.
2. Click **SMART Board Settings**.

The *SMART Board Settings* dialog box appears.
3. Click your AirLiner slate in the **Select a SMART product** area.

A blue border appears around your AirLiner slate.
4. Select **Pen and Button Settings** in the list.

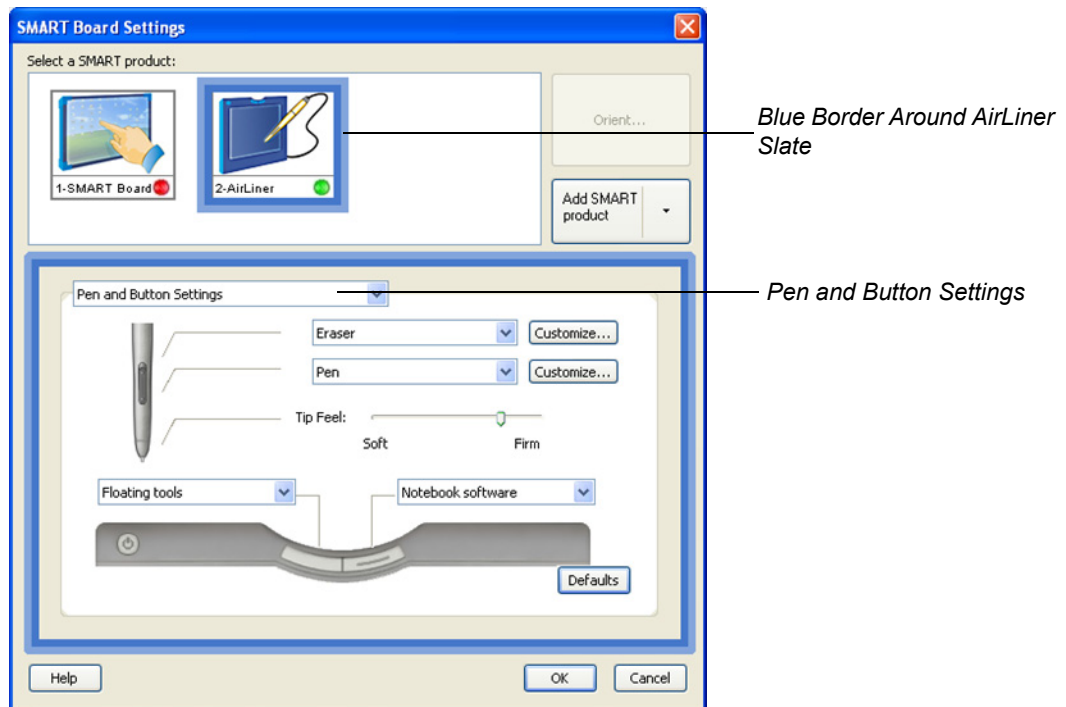

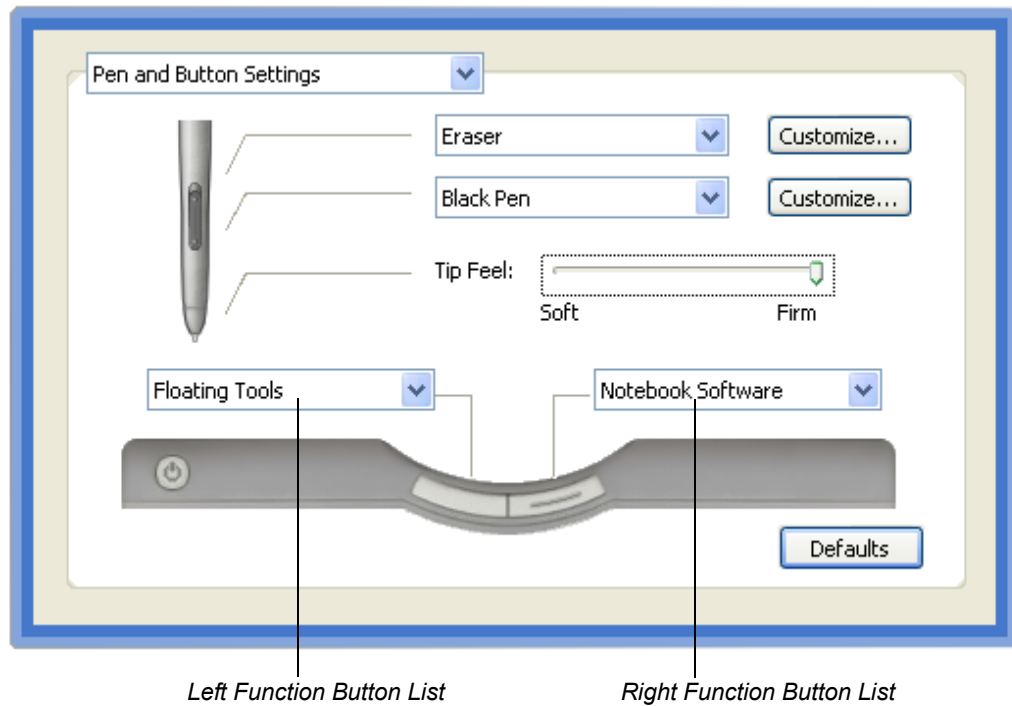

5. Select the desired functions in the right and left function button lists.

List Item	Button Function
Print page	Print the current page in Notebook software.
Next page	Go to the next page in Notebook software.
Previous page	Go to the previous page in Notebook software.
Clear screen	Clear the current page in Notebook software.
Right-click	Right-click. NOTE: This is the default setting for the right mouse button.
Middle-click	Middle-click. NOTE: This is the default setting for the mouse wheel button.
Floating mouse	Prevent clicking and double-clicking with the pen. NOTE: This function doesn't apply to the AirLiner slate. You can select it for other SMART products.
Keyboard	Start the on-screen keyboard.
Floating tools	Start Floating Tools. NOTE: This is the default setting for the left function button.
Notebook software	Start Notebook software. NOTE: This is the default setting for the right function button.
Screen capture toolbar	Start the screen capture tools.
Disabled	Don't attribute a function to the side switch.

6. Click **OK**.

The *SMART Board Settings* dialog box closes.



7. Close the SMART Board software control panel.

Printing and Customizing Underlays

An underlay is a sheet of paper between the AirLiner slate's workspace and its transparent overlay. A tool strip (adjacent) is a toolbar located on the underlay. You can press the icons on the tool strip to select creative tools and start programs.

You can customize underlays and their tool strips, and you can also print templay underlays.

To print a template underlay

1. Start the SMART Board software control panel:
 - Windows operating systems: Click the **SMART Board** icon  in your computer's notification area, and then select **Control Panel**.
 - Mac operating system software: Press and hold the Control key and click the **SMART Board Tools** icon  in the Dock, and then select **Open Control Panel**.
 - Linux operating systems: Select **Applications > SMART Board Software > Control Panel**.
2. Click **SMART Board Settings**.

The *SMART Board Settings* dialog box appears.
3. Click your AirLiner slate in the **Select a SMART product** area.

A blue border appears around your AirLiner slate.



4. Select **Display Properties** in the list.

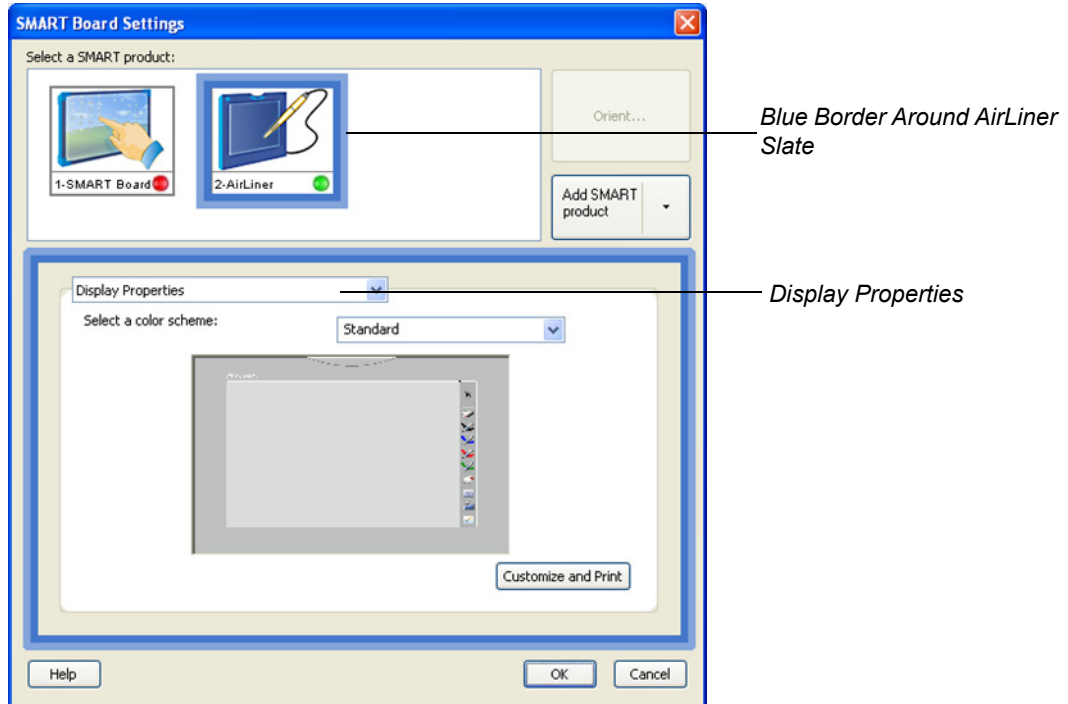

5. Select an underlay template in the **Select a color scheme** list.

6. Click the **Customize and Print** button.

The *Customize and Print Underlays* dialog box appears.

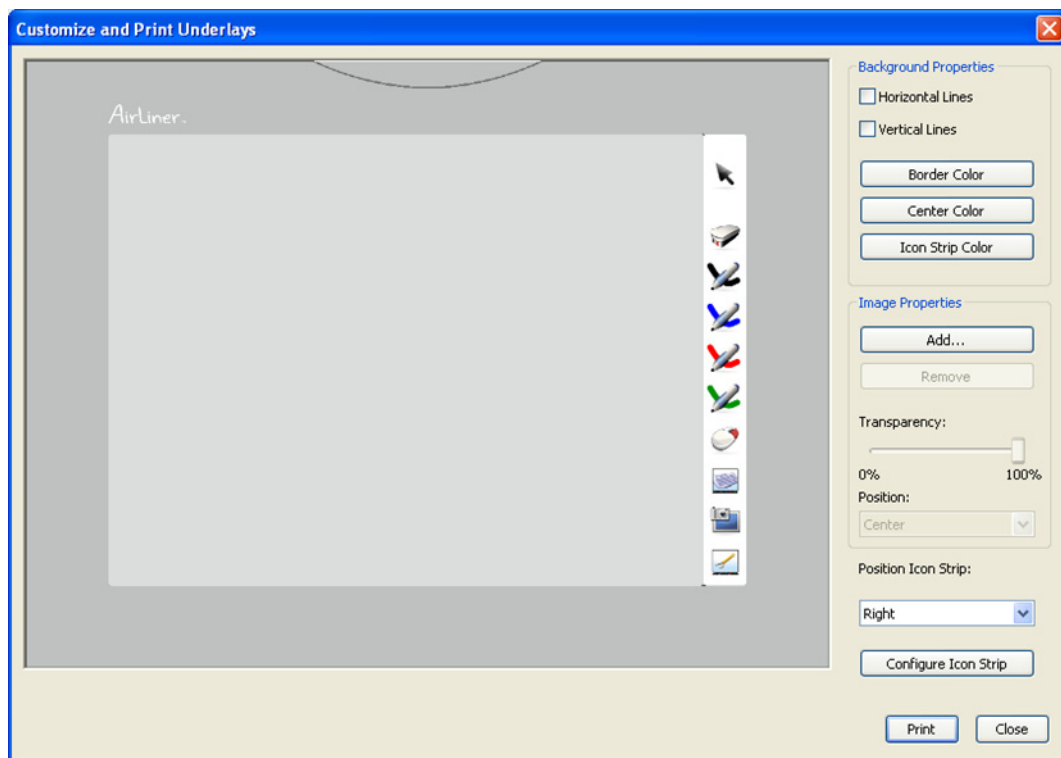

7. Click the **Print** button to print the underlay template.

To customize and print an underlay

1. Open the *Customize and Print Underlays* dialog box by following steps 1 to 6 in the previous procedure.
2. Customize your underlay's lines and colors by selecting attributes in the **Background Properties** area.
3. Customize your underlay's background by selecting attributes in the **Image Properties** area. You can:
 - a. Click the **Add** or **Remove** buttons to change the image in the center of your underlay.
 - b. Move the **Transparency** slider to adjust the center image's opacity.
 - c. Select **Center** or **Stretch** in the **Position** list to adjust how the center image appears.
 - d. Select **Right**, **Left** or **Bottom** in the **Position Icon Strip** list to adjust where the tool strip appears on the underlay.

4. Click the **Configure Icon Strip** button to customize your underlay's tool strip buttons.

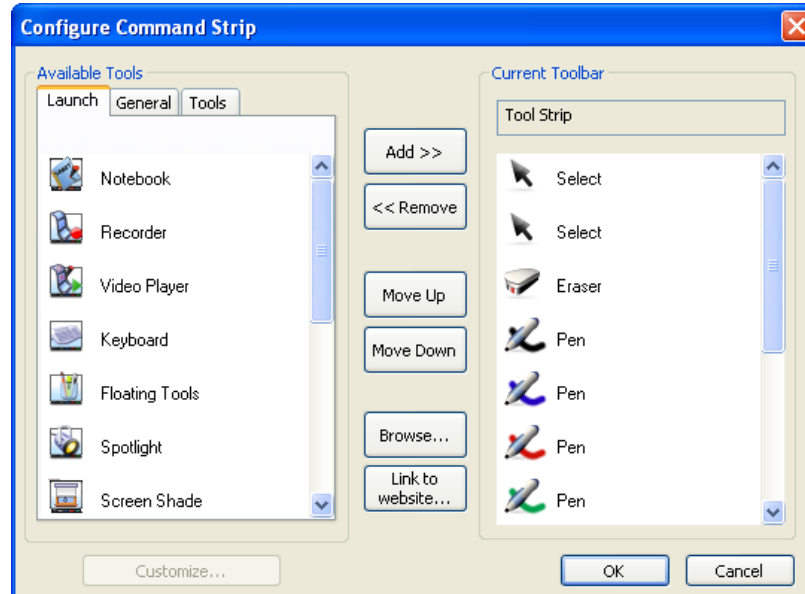

The *Configure Command Strip* dialog box appears.

5. Select items in the **Available Tools** area and click the **Add** button to move them to your underlay's tool strip.
 - Select **Notebook** software, **Calculator**, **Lock AirLiners** and other program buttons from the **Launch** tab.
 - Select **Print**, **Undo**, **Help** and other command buttons from the **General** tab.
 - Select pens, shapes, stamps and other creative tool buttons from the **Tools** tab.

NOTE: To remove a button from your underlay's tool strip, select it in the **Current Toolbar** area, and then click the **Remove** button. To change where a button appears on your underlay's tool strip, select it in the **Current Toolbar** area, and then click the **Move Up** and **Move Down** buttons.

6. Click the **Browse** button to add an executable file to your underlay.

NOTE: Executable files (files with an .exe extension) open programs. For example, if you add **Word.exe** as an executable file button to your underlay's tool strip, you will start Microsoft Word when you press it on your AirLiner slate.

7. Click the **Link to website** button to add a website link to your underlay. When the *Link to website* dialog box appears, type the Web address you want to link to, and then click **OK**. This website opens when you press the button on your AirLiner slate's tool strip.

8. Click **OK** to save your underlay changes. Your changes take effect immediately.
9. Click the **Print** button to print the customized underlay.
10. Click the **Close** button to exit the *Customize and Print Underlays* dialog box.

NOTE: The SMART Board software control panel saves your most recent underlay. The next time you open the *Customize and Print Underlays* dialog box, your latest configuration choices appear.

To customize creative tool buttons (pens, erasers, highlighters, lines, shapes and stamps)

1. Open the *Configure Command Strip* dialog box by following steps 1 to 4 in the previous procedure.
2. Select the tool strip button that you want to customize in the **Current Toolbar** area.
3. Click the **Customize** button at the bottom of the *Configure Command Strip* dialog box.

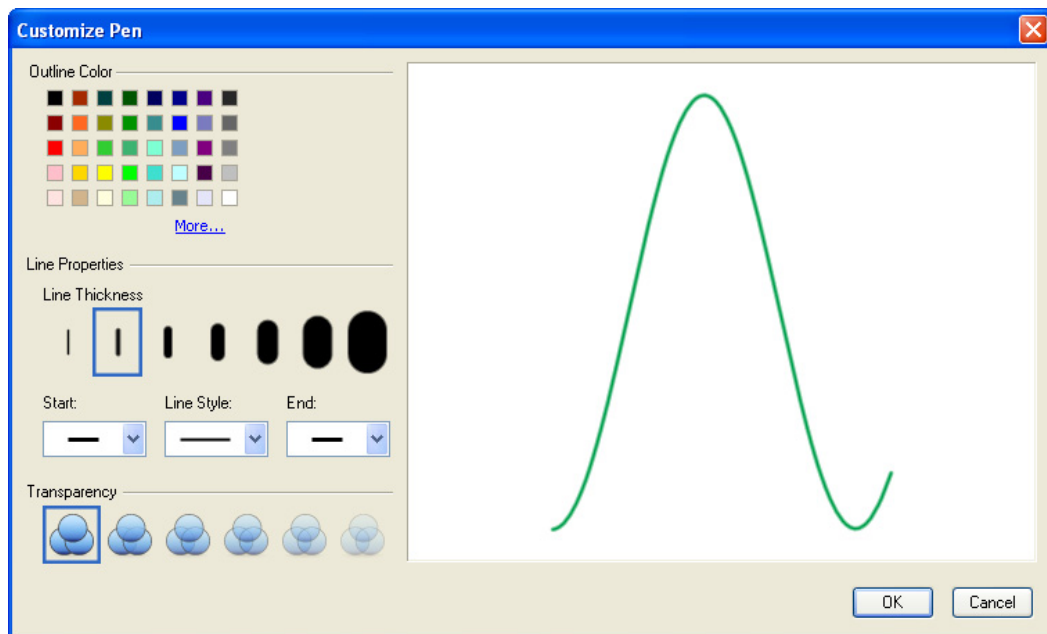

The *Customize Pen* dialog box appears.

4. Select attributes for your button in the **Outline Color**, **Line Properties** and **Transparency** areas.
5. Click **OK** to save the changes to your button.
6. Follow steps 8 to 10 in the previous procedure to save and print your customized underlay.

Mapping to Multiple Displays

The AirLiner slate's workspace is a mapped representation of your display, be it your computer screen, SMART Board interactive whiteboard or Sympodium interactive pen display. Each point on the workspace corresponds to a point on your display. When you move the pen on the slate's workspace, the pointer moves along the corresponding points on your display.

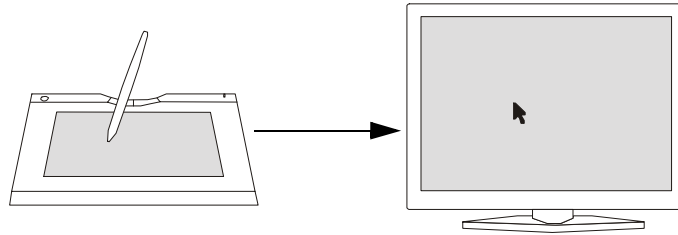

If your computer is connected to multiple displays, you can customize how the tethered pen's movement is mapped to these displays:

- You can map the pen's movement to only one display.

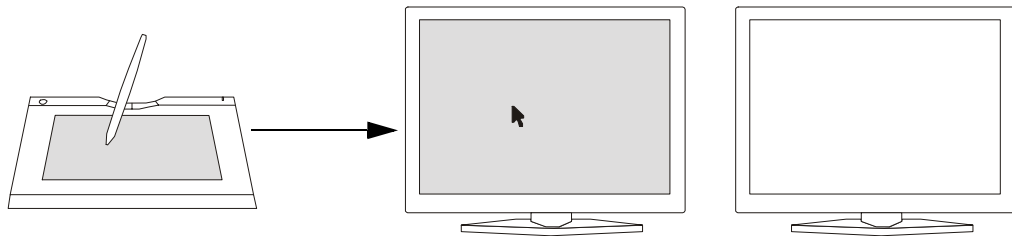

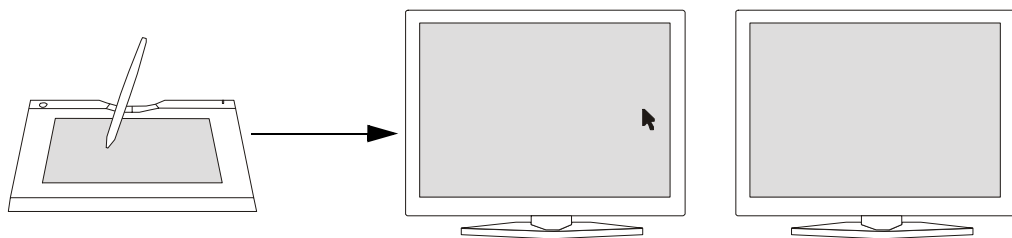

OR

- You can map the pen's movement to the cumulative area of the displays.



NOTE: These settings apply to the tethered pen, but not to the cordless mouse. Because the cordless mouse works like a traditional mouse, you must configure your operating system software if you want to map the cordless mouse's movement to multiple displays.

To map the AirLiner slate to multiple displays

1. Start the SMART Board software control panel:
 - Windows operating systems: Click the **SMART Board** icon  in your computer's notification area, and then select **Control Panel**.
 - Mac operating system software: Press and hold the Control key and click the **SMART Board Tools** icon  in the Dock, and then select **Open Control Panel**.
 - Linux operating systems: Select **Applications > SMART Board Software > Control Panel**.
2. Click **SMART Board Settings**.

The *SMART Board Settings* dialog box appears.
3. Click your AirLiner slate in the **Select a SMART product** area.

A blue border appears around your AirLiner slate.
4. Select **Orientation/Alignment Settings** in the list.

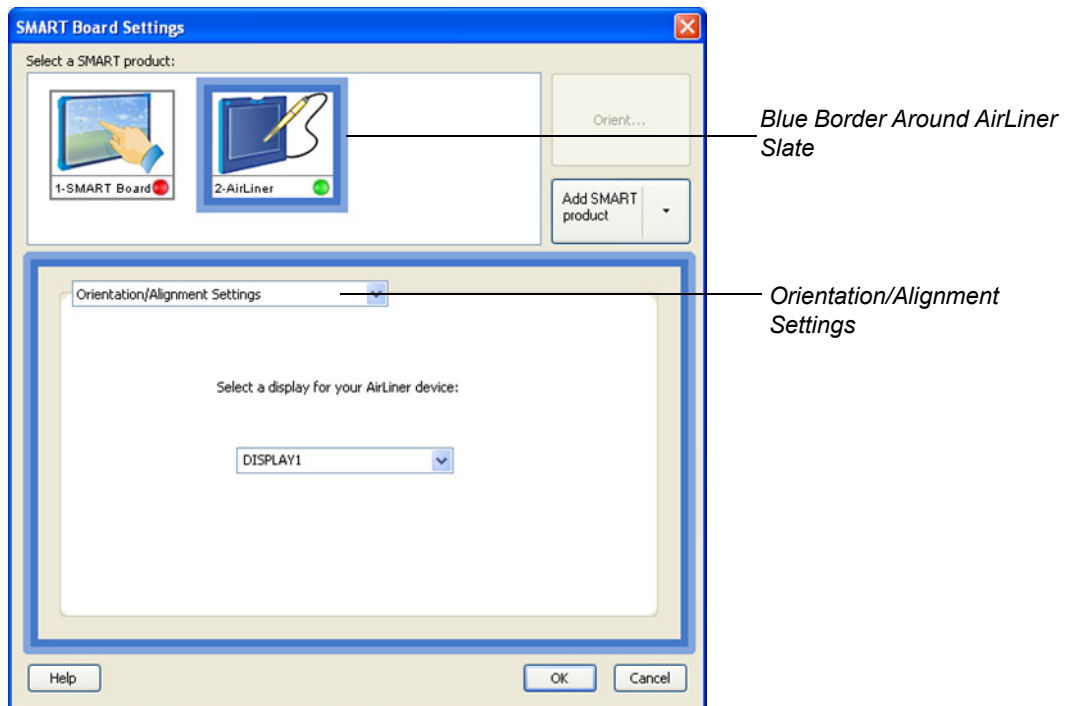

5. To map your pen movements to one display, select the desired display from the list.

OR

To map your pen movements to the cumulative area of the displays, select **Entire Surface** from the list.
6. Click **OK**.

The *SMART Board Settings* dialog box closes.
7. Close the SMART Board software control panel.

Maintaining the Slate

This chapter describes how to maintain the AirLiner slate:

- Clean the slate (this page).
- Replace the tethered pen tip (this page).
- Replace the battery (page 55).

Cleaning the Slate

Regularly clean the AirLiner WS100 wireless slate with a soft, damp cloth to remove dust and dirt particles. If necessary, dampen the cloth using mild soap that is diluted with water.

CAUTION



Do not clean the slate with volatile liquids such as paint thinner or benzene, because they can damage the plastic case.

- When you're not using the slate and its tools, store them in a clean, dry place. Do not expose them to extremes in temperature.
- Do not disassemble the slate or its tools. If you disassemble the slate or its tools, you'll void your warranty.
- Do not attempt to twist the tethered pen open. It must remain a sealed unit, in order to work correctly.

Replacing the Tethered Pen Tip

The tethered pen tip (nib) will wear down with regular use. When the tip becomes too short or develops a flat point, you can replace it with another tip. To order a replacement pen tip (Part No. 45-00008-20), contact SMART Technical Support (page 69).

CAUTION



To maintain the sensitivity of your pen tip, do not store the pen so that it rests on its tip.

To replace the tethered pen tip

1. Grasp the tethered pen tip with an O-ring tool or tweezers.

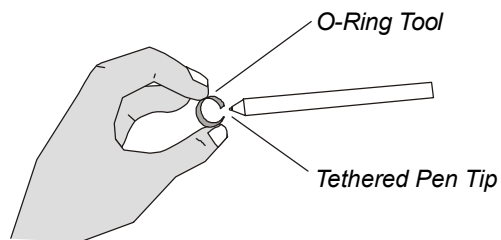

2. Pull the pen tip out of the tethered pen.
3. Insert the replacement pen tip. Firmly push it into the tethered pen's barrel until it stops.

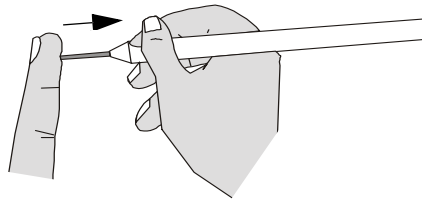

Replacing the Battery

Lithium ion batteries typically need to be replaced every two or three years, whether you use them or not. If your battery no longer recharges (see page 8), contact SMART Technical Support (page 69) to order a new one. Only order and install rechargeable lithium ion batteries that have been designed for the AirLiner WS100 wireless slate.

WARNING



Do not install other battery types in your AirLiner slate. Doing so can damage the slate and can cause a fire or personal injury.

To remove the battery

1. Place the AirLiner slate upside down on a flat surface.
2. Slide open the battery compartment door.

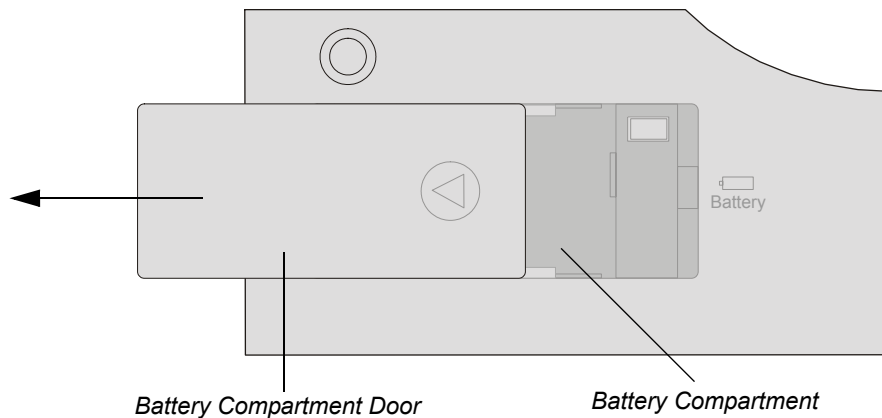

3. Carefully remove the battery by disconnecting the battery connector from the battery receptacle.

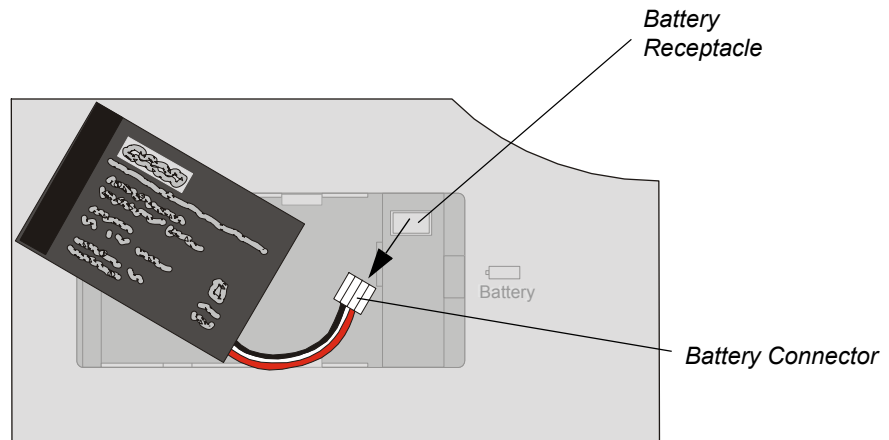

4. Dispose of the battery in accordance with the following recommendations.

WARNING



Keep batteries out of the reach of children.

WARNING



Do not puncture, crush, heat or disassemble the battery, expose it to fire or liquid, short its terminals, or abuse the battery in any other way. Doing so can cause the battery to explode or ignite, and can cause a fire or personal injury.

WARNING



If the battery leaks, do not allow battery fluid to come in contact with your eyes. If battery fluid comes in contact with your eyes, immediately rinse the affected eye(s) with water and seek medical attention.

WARNING



When you dispose of the lithium ion battery, cover the terminals with adhesive tape to prevent contact with metal objects. As an additional precaution, do not transport the battery with metal objects. If the battery comes in contact with a metal object, the battery can short and can cause a fire or personal injury.

Troubleshooting

If your AirLiner WS100 wireless slate isn't working as expected, try the following:

- If an error message appears on your display, follow the instructions suggested in the message.
- If you have new hardware or software that's incompatible with the AirLiner slate, download and install the latest version of SMART Board software at www.smarttech.com/support/software/index.asp.
- Visit www.smarttech.com/support and search for technical bulletins, FAQs and tips relating to the AirLiner slate and SMART Board software.
- If you're using your computer's built-in Bluetooth wireless support or a Bluetooth USB adapter other than the one included with your slate, check the manufacturer's website for technical bulletins, FAQs and tips relating to Bluetooth wireless technology.
- Check the troubleshooting scenarios included in this chapter, and follow the suggested solutions.
- If you're still unable to resolve the issue, contact SMART Technical Support (page 69).

Optimizing the Bluetooth Wireless Connection

If you experience one of the following issues, your Bluetooth wireless connection may not be transmitting data from the slate at the required speed. This may be the result of interference from other radio-frequency signals, obstructions in the radio-frequency wave path, or too large a distance between the slate and the connected computer.

- The pointer's movement on your display lags behind the pen's movement on the slate.
- The pointer jumps from one point to another on your display.
- Straight line segments appear on your display when working with graphics programs.

To resolve the issue, optimize the Bluetooth wireless connection and improve the slate's performance:

- Move metallic objects that block the line of sight between the slate and the Bluetooth USB adapter (if you're using a USB-to-Bluetooth wireless adapter) or your computer (if you're using your computer's built-in Bluetooth wireless support).

NOTE: If you're unable to create a line of sight, and you're using a USB-to-Bluetooth wireless adapter, you can connect the adapter to a USB extension cable connected to your computer, in order to achieve a line of sight between the Bluetooth USB adapter and the slate.

- Use Bluetooth wireless support that complies with Bluetooth wireless specification v1.2. You can upgrade some Bluetooth wireless devices to comply with this specification. For more information, contact the manufacturer of your Bluetooth wireless adapter's (if you're using USB-to-Bluetooth wireless adapter) or your computer's manufacturer (if you're using your computer's built-in Bluetooth wireless support).
- Move the AirLiner slate closer to the Bluetooth wireless adapter (if you're using a USB-to-Bluetooth wireless adapter) or your computer (if you're using your computer's built-in Bluetooth wireless support).

- Disconnect audio devices connected to your computer that use Bluetooth wireless technology, such as headsets.
- Turn off devices operating in the 2.4 GHz band, such as WiFi networks and cell (mobile) phones, or move their antennas further away from your computer.

Troubleshooting Scenarios

Bluetooth Wireless Connection

Bluetooth wireless support isn't available on your computer

To wirelessly connect your slate to your computer, you must first enable a wireless connection (see page 5). If you're using the Bluetooth USB adapter included with the slate, enable to wireless connection using the software CD that comes with the adapter. After you enable the wireless connection, you must create a wireless connection between the AirLiner slate and your computer (see page 20).

When you press the slate's power button, the power indicator turns on, and then turns off

When you turn on the AirLiner slate, it attempts to reconnect to the computer it was last connected to. However, if the slate's power indicator automatically turns off shortly after you turn it on, the slate is unable to make a connection.

- To connect the AirLiner slate to your computer for the first time, create a Bluetooth wireless connection between the slate and your computer (page 20).
- To connect the AirLiner slate to a different computer, create a Bluetooth wireless connection between the slate and the computer (page 20).
- To reestablish a connection between the slate to the same computer (page 22), check the following, and then press the slate's power button:
 - If you're using a Bluetooth USB adapter, fully insert it into your computer's USB port.
 - If you're using a computer with built-in Bluetooth wireless support, enable the support.
 - Check that your computer's Bluetooth wireless connection is working: connect another wireless device that uses Bluetooth wireless technology, such as a wireless keyboard or mouse.
 - Ensure that the AirLiner slate is within the range of your computer's Bluetooth wireless connection. Move metallic objects in or along the slate's line of sight.

NOTE: To determine the operational range of your wireless connection, see the instructions included with your adapter (if you're using a Bluetooth USB adapter) or your computer (if you're using your computer's built-in Bluetooth wireless support).

When you press the power button, the power indicator flashes quickly

When you press the **Connect** button on the back of the slate, the power indicator flashes quickly, indicating that the slate is in discoverable mode and that you can create a wireless connection between the slate and your computer (see page 20).

When you try to create a connection between the slate and your computer, the slate doesn't appear in the list of available devices on your computer

When your Bluetooth software searches for available wireless devices, wait for your computer to search for the AirLiner slate, and then select it. The initial connection may take longer than subsequent connections.

When you create a wireless connection, the slate must be in discoverable mode, and the power indicator must flash quickly. The slate remains in discoverable mode for three minutes.

If the power indicator isn't flashing quickly, complete the following:

1. Move the slate closer to the Bluetooth USB adapter (if you're using a USB-to-Bluetooth wireless adapter) or your computer (if you're using your computer's built-in Bluetooth wireless support).

NOTE: To determine the operational range of the Bluetooth wireless connection, see the instructions included with the adapter (if you're using a USB-to-Bluetooth wireless adapter) or your computer (if you're using your computer's built-in Bluetooth wireless support).

2. Move metallic objects in or along the slate's line of sight.
3. Press the **Connect** button on the back of the slate to switch the slate to discoverable mode.
4. Create a wireless connection between the AirLiner slate and your computer (see page 20).

When you try to create a wireless connection between the AirLiner slate and your computer, a "pairing unsuccessful" message appears

Turn off, or move, other wireless devices connected to your computer that may be interfering with the Bluetooth wireless connection, including other wireless slates. Then, create the wireless connection (see page 20)

You successfully connected the slate to your computer, but the wireless connection isn't working as expected.

Remove SMART Board software from your computer, and then install it again. For more information, see the SMART Board software online Help.

If the wireless connection is slow, optimize the Bluetooth wireless connection (see page 57).

Battery and Power Adapter

When you press the power button, the power indicator doesn't turn on.

Press the power button again. If the power indicator doesn't turn on, the battery charge may be insufficient to turn on the slate. Connect the power adapter to the slate and a power outlet, and then press the power button again.

If the power indicator turns on and the charging indicator turns orange, the battery is recharging. Recharge the battery until the charging indicator turns green. You can use the slate when the battery is recharging.

If neither the power indicator nor the charging indicator turns on, your battery can no longer hold sufficient charge. Order a new battery from SMART Technical Support (see page 69).

The AirLiner slate works when it's connected to an external power source, but turns off when it isn't

Remove the battery. Check that there is no leakage or other damage to the battery. If the battery is damaged, order a new one (Part No. 01-00173) from SMART Technical Support (page 69).

If there's no indication of damage to the battery, insert the battery into the slate and connect the power adapter to the slate and a power outlet (see page 6). Recharge the battery until the charging indicator turns green. You can use the slate when the battery is recharging.

If the following three issues arise, your battery is completely drained, and you must order a new one (Part No. 01-00173) from SMART Technical Support (see page 69).

- You're unable to use the AirLiner slate wirelessly after recharging the battery.
- The battery status is low (partially red) after recharging it (see page 10).
- The charging indicator remains turned off when you connect the slate to a power outlet.

When you connect the power adapter cable to the slate and a power outlet, the charging indicator doesn't turn on

Disconnect the power adapter from the power outlet, and then connect another electrical device, to make sure the power outlet is working and active.

If the power outlet is working, disconnect the electrical device. Check for damage to the power adapter. If there is no damage, ensure that the power cable and power supply are securely connected (page 8), and then reconnect the slate to the power outlet.

If the issue persists, the battery can no longer hold sufficient charge to turn on the slate. Order a new battery (Part No. 01-00173) from SMART Technical Support (see page 69).

The power indicator flashes slowly

When the power indicator flashes slowly, the battery's charge is low and will soon be insufficient to power the slate.

Connect the power adapter to the slate and a power outlet, and then recharge the battery (see page 8). The charging indicator turns green when the battery is fully charged. You can use the slate when the battery is recharging.

Tethered Pen

When you move the pen tip across the workspace, the pointer doesn't move on the display

Complete the following procedures. After completing each procedure, move the tethered pen across the slate's workspace to verify if the issue is resolved.

- Press the slate's power button to turn off the slate. Wait 10 seconds, and then press the power button to turn on the slate again.
- If the power indicator flashes slowly, the battery's charge is low and will soon be insufficient to power the slate. Connect the power adapter to the slate and a power outlet, in order to recharge the battery (see page 8). The charging indicator turns green when the battery is fully charged.
- Disconnect the power adapter from the power outlet (if it's connected), and then remove the battery from the battery compartment (see page 55). Wait 10 seconds, and then reconnect the battery and insert it into the battery compartment. Connect the power adapter to the slate and a power outlet (see page 6).

If the issue persists, contact SMART Technical Support (see page 69).

When you move the pen tip across the workspace, the pointer moves on the display, and then it returns to its previous location

Ensure that the cordless mouse isn't resting on the slate, because it will interfere with pointer positioning.

When you move the pen tip across the workspace, the pointer's movement on the display is unpredictable and inconsistent

Complete the following procedures. After completing each procedure, move the tethered pen across the slate's workspace to verify if the issue is resolved.

- Ensure that you're using the tethered pen correctly (see page 26).
- Turn off or move all wireless devices that can interfere with the Bluetooth wireless connection (except for your computer and the AirLiner slate). Then, reestablish the wireless connection (see page 22).
- Place the slate at least 6' (1.8 m) from your display monitor.
- Change the monitor's refresh rate or resolution until the issue is resolved.
- Optimize the Bluetooth wireless connection, because the Bluetooth wireless connection may not be transmitting data from the slate at the required speed (see page 57).

If the issue persists, contact SMART Technical Support (see page 69).

When you move the pen tip across the workspace, the pointer's movement on the display is delayed or it jumps

Optimize the Bluetooth wireless connection, because the Bluetooth wireless connection may not be transmitting data from the slate at the required speed (see page 57).

After you customize the tethered pen, it doesn't work as expected

Turn off your computer, and then turn it on again. The wireless connection between your computer and the AirLiner slate is automatically reestablished after you turn on the computer. You can use the tethered pen after the wireless connection is reestablished.

The pen's side switch doesn't work as expected

Complete steps 1 to 8 on page 38, and verify that the upper and lower side switches are set to the functions you want.

Move the pen tip within 1/4" (6.5 mm) of the workspace, but not touching it, and then press and hold the side switch. If the power indicator turns green when you press the side switch, the issue may be due to a problem with the tethered pen. However, if the power indicator remains blue when you press the side switch, the issue may be due to a problem with the slate. Contact SMART Technical Support (page 69).

It's difficult to click buttons and other parts of the display

Adjust the Tip Feel of the tethered pen (page 37).

It's difficult to double-click buttons and other parts of the display

Increase the Double-Click Zone (page 37).

NOTE: If you're working with a Windows operating system, you can adjust your operating system settings to enable programs to start with a single-click. For more information, see the instructions that came with your operating system.

The tethered pen selects everything on the display, or doesn't it stop drawing, because the pen tip is too sensitive

Set the Tip Feel to a firmer setting (page 37).

You have to press the pen tip hard on the workspace, in order to draw or move the pointer

Set the Tip Feel to a softer setting (page 37).

Cordless Mouse

When you move the cordless mouse across the workspace, the pointer doesn't move on the display

Complete the following procedures. After completing each procedure, move the cordless mouse across the slate's workspace to verify if the issue is resolved.

- Press the slate's power button to turn off the slate. Wait 10 seconds, and then press the power button to turn on the slate again.
- If the power indicator flashes slowly, the battery's charge is low and will soon be insufficient to power the slate. Connect the power adapter to the slate and a power outlet, in order to recharge the battery (see page 8). The charging indicator turns green when the battery is fully charged.
- Disconnect the power adapter from the power outlet (if it's connected), and then remove the battery from the battery compartment (see page 55). Wait 10 seconds, and then reconnect the battery and insert it into the battery compartment. Connect the power adapter to the slate and a power outlet (see page 6).

If the issue persists, contact SMART Technical Support (see page 69).

When you move the cordless across the workspace, the pointer moves on the display, and then it returns to its previous location

Ensure that the tethered pen isn't resting on the slate, because it will interfere with pointer positioning.

When you move the cordless mouse across the workspace, the pointer's movement on the display is unpredictable and inconsistent

After you complete each of the following procedures, move the cordless mouse across the slate's workspace to verify if the issue is resolved.

Complete the following procedures. After completing each procedure, move the tethered pen across the slate's workspace to verify if the issue is resolved.

- Ensure that you're using the cordless mouse correctly (see page 33).
- Turn off or move all wireless devices that can interfere with the Bluetooth wireless connection (except for your computer and the AirLiner slate). Then, reestablish the wireless connection (see page 22).
- Place the slate at least 6' (1.8 m) from your display monitor.
- Change the monitor's refresh rate or resolution until the issue is resolved.
- Optimize the Bluetooth wireless connection, because the Bluetooth wireless connection may not be transmitting data from the slate at the required speed (see page 57).

If the issue persists, contact SMART Technical Support (see page 69).

When you move the cordless mouse across the workspace, the pointer's movement on the display lags or it jumps

Optimize the Bluetooth wireless connection, because your Bluetooth wireless connection may not be transmitting data from the slate at the required speed (see page 57).

The cordless mouse buttons don't work as expected

1. Press a mouse button.
2. If the power indicator remains blue when you press the mouse button, press and hold a function button.

If the power indicator turns green when you press and hold a function button, the issue may be due to a problem with the cordless mouse. However, if the power indicator remains blue when you press the side switch, the issue may be due to a problem with the slate. Contact SMART Technical Support (page 69).

After you customize the cordless mouse settings, the cordless mouse doesn't work as expected

Turn off your computer, and then turn it on again. The wireless connection between your computer and the AirLiner slate is automatically reestablished after you turn on the computer. You can use the cordless mouse after the wireless connection is reestablished.

Function Buttons

The function buttons don't work as expected

Complete steps 1 to 7 on page 44, and verify that the right and left function buttons are set to the functions you want.

Press a function button. If the power indicator remains blue when you do so, place the cordless mouse on the slate's workspace, and then press a mouse button. If the power indicator turns green when you do so, the issue may be due to a problem with the function button. However, if the power indicator remains blue when you press a mouse button, the issue may be due to a problem with the slate. Contact SMART Technical Support (page 69).

After you customize the function buttons, they don't work as expected

Turn off your computer, and then turn it on again. The wireless connection between your computer and the AirLiner slate is automatically reestablished after you turn on the computer. You can use the tethered pen after the wireless connection is reestablished.

Multiple Displays

The connected computer is linked to multiple displays, but you're unable to move the pointer from one display to another.

Complete steps 1 to 7 on page 52, selecting **Entire Surface** from the list in step 5.

NOTE: There are different methods for defining the arrangement of multiple displays, depending on your operating system. For further information, refer to the instructions for your operating system.

Multiple Users

You installed the slate on a computer with multiple users, but the slate only works for the primary user.

Turn off your computer, and then turn it on again. Multiple user settings take effect after you restart the computer.

Regulatory Compliance

Waste Electrical and Electronic Equipment Regulations

Waste Electrical and Electronic Equipment regulations apply to all electrical and electronic equipment sold within the European Union.

When you dispose of any electrical or electronic equipment, including SMART products, we strongly encourage you to contact your local WEEE recycling agency for recycling and disposal advice.

Your SMART product required the extraction and use of natural resources for its production. It may contain hazardous substances. By disposing of electrical and electronic equipment appropriately, you lower the impact of these substances upon health and the environment and reduce the pressure on natural resources. Recycling agencies can reuse or recycle most of the materials from your product.

Please think about how you intend to dispose of any product that has a WEEE symbol or accompanying WEEE guidelines.



If you need more information on the collection, reuse and recycling of electrical and electronic equipment, please contact your local WEEE recycling agency.

Alternatively, contact your local reseller or SMART Technologies for information on the environmental performance of our products.

Restriction of Certain Hazardous Substances (RoHS) Directives

SMART Technologies supports global efforts to ensure that electronic equipment is manufactured, sold and disposed of in a safe and environmentally friendly manner.

This product meets the requirements of the European Union's Restriction of Certain Hazardous Substances (RoHS) Directive 2002/95/EC, as well as the People's Republic of China's Control of Pollution Caused by Electronic Information Products (China RoHS).

Subsequently, this product also complies with other, less stringent directives that have arisen in various geographical areas, and that incorporate the European Union's RoHS directive as a basis.

For more information, refer to your local regulations or visit www.smarttech.com.

Customer Support

Online Support

Visit www.smarttech.com/support to view and download user's guides, "how-to" and troubleshooting articles, software and more.

Training

Visit www.smarttech.com/trainingcenter for training materials and information about our training services.

Contacting SMART Technical Support

SMART Technical Support welcomes your call. However, if you experience difficulty with your SMART product, you may want to contact your local reseller first. Your local reseller may be able to resolve the issue without delay.

All SMART products include online, telephone, fax and e-mail support:

Online: www.smarttech.com/contactsupport

Telephone: +1.403.228.5940 or
Toll Free 1.866.518.6791 (Canada/U.S.)
(Monday to Friday, 5 a.m. – 6 p.m. Mountain Time)

Fax: +1.403.806.1256

E-mail: support@smarttech.com

General Inquiries

Address: **SMART Technologies**
1207 – 11 Ave SW, Suite 300
Calgary, AB T3C 0M5
CANADA

Switchboard: +1.403.245.0333 or
Toll Free 1.888.42.SMART (Canada/U.S.)

Fax: +1.403.228.2500

E-mail: info@smarttech.com

Warranty

Product warranty is governed by the terms and conditions of SMART's "Limited Equipment Warranty" that shipped with the SMART product at the time of purchase.

Registration

To help us serve you, register online at www.smarttech.com/registration.

Index

A

- AirLiner Slate
 - Locking, 34
- AirLiner Wireless Slate
 - Cleaning, 53
 - Customizing, 37
 - Features, 1
 - Installing, 5
 - Introduction, 1
 - Maintaining, 53
 - Turning Off, 24
 - Turning On, 19
- Anti-Slip Feet, 2
 - Installing, 15

B

- Band
 - 2.4 GHz, 58
- Battery, 2
 - Draining, 12
 - Installing, 6
 - Recharging, 8
 - Replacing, 55
 - Status (Charge), 10
- Battery Compartment, 2
- Blocking
 - see Locking the AirLiner Slate*
- Bluetooth
 - Installing Software, 6
- Bluetooth Wireless Connection
 - see Wireless Connection*

C

- Charging Indicator, 1, 9
- Cleaning the AirLiner Wireless Slate, 53
- Clicking
 - Double-Clicking, 29
 - Single-Clicking, 29
- Connect Button, 2, 21, 22
- Connection
 - Broken (Disconnected), 22
- Coordination
 - see Hand-Eye Coordination*

Cordless Mouse

- Customizing, 33
 - Using, 33
 - Writing with Digital Ink, 33
- Creating a Wireless Connection, 19
- Creative Tool, 31
- Customizing
- AirLiner Wireless Slate, 37
 - Cordless Mouse, 33
 - Eraser, 41
 - Function Buttons, 44
 - Side Switch, 38
 - Tethered Pen, 37, 41
 - Tool Strip, 46
 - Underlay, 48

D

- DC IN Receptacle, 2, 9
- Delay
 - see Lag*
- Digital Ink, 31
- Disconnecting
 - Wireless Connection, 23
- Discoverable Mode, 21
- Double-Click Zone, 29, 43, 62
- Double-Clicking, 29
- Dragging, 29

E

- Enable Hover, 27, 43
- Enabling the Wireless Connection, 5
- Eraser
 - Customizing, 41
- Erasing, 31
- Erratic Pointer Movement
 - see Pointer*

F

- Function Buttons, 1
 - Customizing, 44
 - Using, 34

H

Hand-Eye Coordination, 27, 32
Headsets, 58
HID
 see Human Interface Device
Hover, 27, 43
Human Interface Device, 5

I

Icon Strip
 see Tool Strip, 30, 49
Installing
 AirLiner Wireless Slate, 5
 Anti-Slip Feet, 15
 Battery, 6
 SMART Board Software, 18
 Tethered Pen, 16
 Underlay, 13

J

Jumping
 Pointer, 57, 61, 64

L

Lag, 57, 64
Line of Sight, 57
Lithium Ion Battery
 see Battery
Locking
 AirLiner Slate, 34
Locking Slider, 2, 14

M

Maintaining the AirLiner Wireless Slate, 53
Mapped Display, 27, 51
Mapping to Multiple Displays, 51
 Entire Surface, 52
 Orientation/Alignment Settings, 52
Mouse
 see Cordless Mouse
Mouse Settings, 28, 42
 Enable Hover, 43

O

Optimizing the Wireless Connection, 57
Orientation/Alignment Settings, 52
Overlay, 2

P

Paper Underlay
 see Underlay
Pen
 see Tethered Pen
Pen and Button Settings, 37, 39
Pen Nib
 see Tethered Pen Tip
Pen Storage Compartment
 see Tethered Pen Storage Compartment, 1, 26
Pointer
 Unpredictable Movement (Erratic), 61, 63
Pointing, 27
Power Adapter, 3
Power Button, 19
 Flashing Blue, 12
Power Indicator, 1, 19

R

Recharging the Battery, 8
 Overcharging, 12
Registering Your Slate, 70
Regulations, 20, 67
Replacing
 Battery, 55
 Tethered Pen Tip
Restriction of Certain Hazardous Substances
(RoHS), 67

S

Selecting Text, 29
Side Switch
 Clear Screen, 40
 Customizing, 38
 Disabled, 40
 Eraser, 40
 Floating Mouse, 40
 Floating Tools, 40
 Keyboard, 40
 Middle-Click, 40
 Next Page, 40
 Notebook Software, 40

- Pen, 40
- Previous Page, 40
- Print Page, 40
- Right-Click, 40
- Screen Capture Toolbar, 40
- Using, 30
- Skipping
 - see Jumping (Pointer), 64*
- Slate
 - see AirLiner Wireless Slate*
- SMART Board Interactive Whiteboard, 1
- SMART Board Software
 - Installing, 18
- Symposium Interactive Pen Display, 1

T

- Technical Support
 - Contacting, 69
- Terminating a Wireless Connection
 - see Disconnecting*
- Tethered Pen, 3
 - Applying Pressure, 37
 - Customizing, 37, 41
 - Installing, 16
 - Using, 26
- Tethered Pen Storage Compartment, 1, 26
- Tethered Pen Tip
 - Replacing
- Tip Feel, 37
- Tool Strip, 49
 - Customizing, 46
 - Using, 30
- Troubleshooting, 57
- Turning Off the AirLiner Wireless Slate, 24
- Turning On the AirLiner Wireless Slate, 19

U

- Underlay
 - Customizing, 48
 - Installing, 13
 - Printing, 46
 - Template, 46
- USB Extension Cable, 57
- Using
 - Cordless Mouse, 33
 - Functions Buttons, 34
 - Side Switch, 30
 - Tethered Pen, 26
 - Tool Strip, 30

W

- Warranty, 70
- Waste Electrical and Electronic Equipment Regulations (WEEE), 67
- Wireless Connection
 - Creating, 19
 - Disconnecting, 23
 - Enabling, 5
 - Optimizing, 57
 - Reconnecting, 22
 - Reestablishing, 22
- Wireless Slate
 - see AirLiner Wireless Slate*
- Workspace, 1, 26



SMART Technologies

1207 – 11 Avenue SW, Suite 300

Calgary, AB T3C 0M5

CANADA

www.smarttech.com/support

www.smarttech.com/contactsupport

Support +1.403.228.5940

Toll Free 1.866.518.6791 (Canada/U.S.)

99-00666-20 REV B0